

Dell™ Inspiron™ 8100 Systems

Solutions Guide



Hints, Notices, and Cautions



HINT: A HINT indicates important information that helps you make better use of your computer.



NOTICE: A NOTICE indicates either potential damage to hardware or loss of data and tells you how to avoid the problem.



CAUTION: A CAUTION indicates a potentially hazardous situation which, if not avoided, may result in minor or moderate injury.

Abbreviations and Acronyms

For a complete list of abbreviations and acronyms, see the *Tell Me How* help file (click the **Start** button on the Microsoft® Windows® desktop, point to **Programs**—> **User's Guides**, and click **Tell Me How**).

Information in this document is subject to change without notice.
© 2001 Dell Computer Corporation. All rights reserved.

Reproduction in any manner whatsoever without the written permission of Dell Computer Corporation is strictly forbidden.

Trademarks used in this text: *Dell*, *Dell TravelLite*, *Inspiron*, *DellWare*, *TrueMobile*, *Dimension*, *OptiPlex*, *Dell Precision*, and *Latitude* are trademarks of Dell Computer Corporation; *Intel* and *Pentium* are registered trademarks and *Celeron* is a trademark of Intel Corporation; *GeForce2 Go* is a trademark of NVIDIA Corporation; *Microsoft* and *Windows* are registered trademarks of Microsoft Corporation.

Other trademarks and trade names may be used in this document to refer to either the entities claiming the marks and names or their products. Dell Computer Corporation disclaims any proprietary interest in trademarks and trade names other than its own.

This product incorporates copyright protection technology that is protected by method claims of certain U.S. patents and other intellectual property rights owned by Macrovision Corporation and other rights owners. Use of this copyright protection technology must be authorized by Macrovision Corporation, and is intended for home and other limited viewing uses only unless otherwise authorized by Macrovision Corporation. Reverse engineering or disassembly is prohibited.

Contents

Safety and EMC Instructions:	
Portable Computers	7
Safety Instructions	7
EMC Instructions	10
When Using Your Computer	11
When Removing or Installing Memory Modules	12
Protecting Against Electrostatic Discharge	13

1 Setting Up

Connecting a Printer	16
Installing the Printer Driver	16
Parallel Printer	16
USB Printer	17
Turning Off the Computer	18
Windows Millennium Edition (Me) and Windows 2000	18
Using the Media Bay	19
Swapping Devices While the Computer Is Turned Off	20
Swapping Devices While Windows Is Running	21
Setting Up the Dolby Headphone	22
Setting Up the APR to Connect to a Network	22
Setting Up the APR for Windows Me	22
Setting Up the APR for Windows 2000	23

2 Solving Problems

Finding Solutions	26
Accessing Help Files	28
Power Problems	28
Start-Up Error Messages	29
Video and Display Problems	30
If the display is blank	30
If the display is difficult to read	30
Sound and Speaker Problems	31
Integrated Speakers	31
External Speakers	31
Printer Problems	32
If you cannot print to a parallel port printer	32
If you cannot print to a USB printer	33
Modem Problems	33
Scanner Problems	34
Touch Pad Problems	35
External Keyboard Problems	35
Unexpected Characters	35
Drive Problems	36
If you cannot save a file to a floppy disk	36
If you cannot play a music CD or install a program from a CD	37
If you cannot play a DVD movie	38
If the CD-RW drive stops writing	38
If you have a hard drive problem	38
Network Problems	39

Windows Error Messages	39
General Program Problems	40
A program crashes	40
A program stops responding	40
A solid blue screen appears	41
Internet Connection Problems	41
E-Mail Problems	42
If Your Computer Gets Wet	42
If You Drop or Damage Your Computer	43
Resolving Other Technical Problems	44
Reinstalling Drivers and Utilities	44
Reinstalling Windows	45
Reinstalling Windows Me	45
Reinstalling Windows 2000	47

3 Adding Parts

Replacing the Palm Rests	50
Using the Advanced Port Replicator	51
Connecting External Devices to the APR	51
APR Controls and Indicators	53
Docking the Computer	54
Undocking the Computer	55
Monitor Stand	56
Adding Memory	57
Installing a Mini PCI Card	59
Replacing a Hard Drive	62
Returning a Hard Drive to Dell	64

4 Appendix

Specifications	66
Standard Settings	72
System Setup Pages	72
Viewing the System Setup Pages	73
Contacting Dell	73
Contact Numbers and Addresses	73
Returning Items for Warranty Repair or Credit	87
Regulatory Information	87
General EMC Guidelines	87
FCC Notices (U.S. Only)	88
Battery Disposal	91
NOM Information (Mexico Only)	92
Información para NOM (únicamente para México)	93
Limited Warranties and Return Policy	93
One-Year Limited Warranty (U.S. Only)	94
Two-Year Limited Warranty (U.S. Only)	96
Three-Year Limited Warranty (U.S. Only)	99
One-Year Limited Warranty (Canada Only)	102
Two-Year Limited Warranty (Canada Only)	104
Three-Year Limited Warranty (Canada Only)	107
“Total Satisfaction” Return Policy (U.S. and Canada Only)	111
One-Year End-User Manufacturer Guarantee (Latin America and the Caribbean Only)	112

Index	115
------------------------	------------

Safety and EMC Instructions: Portable Computers

The following information defines the meaning of symbols used in the Safety and Electromagnetic Compatibility (EMC) Instructions.



Attention



Risk of electric shock



Risk of explosion



Aircraft



Risk of fire



Use of this feature may be prohibited on aircraft

Safety Instructions



General

- Do not attempt to service the computer yourself. Always follow installation instructions closely.
- If you use an extension power cable with your AC adapter, ensure that the total ampere rating of the products plugged in to the extension power cable does not exceed the ampere rating of the extension cable.
- Do not push objects into air vents or openings of your computer. Doing so can cause fire or electric shock by shorting out interior components.
- Place the AC adapter in a ventilated area, such as a desk top or on the floor, when you use it to run the computer or to charge the battery. Do not cover the AC adapter with papers or other items that will reduce cooling; also, do not use the AC adapter inside a carrying case.





- Do not allow your portable computer to operate with the base resting directly on exposed skin, for example, legs, for an extended period of time. With extended operation, heat can potentially build up in the base. Allowing sustained contact with the skin could cause discomfort or, eventually, a burn.
- Do not use your computer in a wet environment, for example, near a bath tub, sink, or swimming pool or in a wet basement.
- If your computer includes an integrated or optional (PC Card) modem, disconnect the modem cable if an electrical storm is approaching to avoid the remote risk of electric shock from lightning via the telephone line.
- To help avoid the potential hazard of electric shock, do not connect or disconnect any cables or perform maintenance or reconfiguration of this product during an electrical storm. Do not use your computer during an electrical storm unless all cables have been disconnected and the computer is operating on battery power.
- If your computer includes a modem, the cable used with the modem should be manufactured with a minimum wire size of 26 American wire gauge (AWG) and an FCC-compliant RJ-11 modular plug.
- PC Cards may become very warm during normal operation. Use care when removing PC Cards after their continuous operation.
- Before you clean your computer, remove power. Clean your computer with a soft cloth dampened with water. Do not use liquid or aerosol cleaners, which may contain flammable substances.



Power (Safety Instructions, continued)

- Use only the Dell-provided AC adapter approved for use with this computer. Use of another AC adapter may cause a fire or explosion.
- Before you connect the computer to an electrical outlet, check the AC adapter voltage rating to ensure that the required voltage and frequency match the available power source.
- To remove power from the computer, turn it off, remove the battery pack, and disconnect the AC adapter from the electrical outlet.

- To help prevent electric shock, plug the AC adapter and peripheral power cables into properly grounded power sources. These power cables may be equipped with three-prong plugs to provide an earth grounding connection. Do not use adapter plugs or remove the grounding prong from the power cable plug. If you use a power extension cable, use the appropriate type, two-prong or three-prong, to mate with the AC adapter power cable.
- Be sure that nothing rests on your AC adapter's power cable and that the cable is not located where it can be tripped over or stepped on.
- If you are using a multiple-outlet power strip, use caution when plugging the AC adapter's power cable into the power strip. Some power strips may allow you to insert the plug incorrectly. Incorrect insertion of the power plug could result in permanent damage to your computer, as well as risk of electric shock and/or fire. Ensure that the ground prong of the power plug is inserted into the mating ground contact of the power strip.



Battery (Safety Instructions, continued)

- Use only Dell battery modules that are approved for use with this computer. Use of other types may increase the risk of fire or explosion.
- Do not carry a battery pack in your pocket, purse, or other container where metal objects (such as car keys or paper clips) could short-circuit the battery terminals. The resulting excessive current flow can cause extremely high temperatures and may result in damage to the battery pack or cause fire or burns.
- The battery poses a burn hazard if you handle it improperly. Do not disassemble it. Handle a damaged or leaking battery pack with extreme care. If the battery is damaged, electrolyte may leak from the cells and may cause personal injury.
- Keep away from children.
- Do not store or leave your computer or battery pack near a heat source such as a radiator, fireplace, stove, electric heater, or other heat-generating appliance. When heated to excessive temperatures, battery cells could explode or vent, posing a risk of fire.





- Do not dispose of your computer's battery in a fire or with normal household waste. Battery cells may explode. Discard a used battery according to the manufacturer's instructions or contact your local waste disposal agency for disposal instructions. Dispose of a spent or damaged battery promptly.

Air Travel (Safety Instructions, continued)

- Certain Federal Aviation Administration regulations and/or airline-specific restrictions may apply to the operation of your Dell™ computer while you are onboard an aircraft. For example, such regulations/restrictions may prohibit the use of any personal electronic device (PED) that has the capacity for intentional transmission of radio frequency or other electromagnetic signals while on an aircraft.
 - In order to best comply with all such restrictions, if your Dell portable computer is equipped with Dell TrueMobile™ or some other wireless communication device, please disable this device before you board the aircraft and follow all instructions provided by airline personnel with regard to such device.
 - Additionally, the use of any PED, such as a portable computer, may be prohibited in aircraft during certain critical phases of flight, for example, takeoff and landing. Some airlines may further define the critical flight phase as any time the aircraft is below 3050 m (10,000 ft). Please follow the airline's specific instructions as to when the use of a PED is allowed.

EMC Instructions

- Use shielded signal cables to ensure that you maintain the appropriate EMC classification for the intended environment. For parallel printers, a cable is available from Dell. If you prefer, you can order a cable from Dell at its world-wide website at <http://www.dell.com>.
- Static electricity can harm electronic components inside your computer. To prevent static damage, discharge static electricity from your body before you touch any of your computer's electronic components, such as a memory module. You can do so by touching an unpainted metal surface on the computer's input/output panel.

When Using Your Computer

Observe the following safety guidelines to prevent damage to your computer:

- When setting up the computer for work, place it on a level surface.
 - When traveling, do not check the computer as baggage. You can put your computer through an X-ray security machine, but never put your computer through a metal detector. If you have the computer checked by hand, be sure to have a charged battery available in case you are asked to turn on the computer.
 - When traveling with the hard drive removed from the computer, wrap the drive in a nonconducting material, such as cloth or paper. If you have the drive checked by hand, be ready to install the drive in the computer. You can put the hard drive through an X-ray security machine, but never put the drive through a metal detector.
 - When traveling, do not place the computer in overhead storage compartments where it could slide around. Do not drop your computer or subject it to other mechanical shocks.
 - Protect your computer, battery, and hard drive from environmental hazards such as dirt, dust, food, liquids, temperature extremes, and overexposure to sunlight.
 - When you move your computer between environments with very different temperature and/or humidity ranges, condensation may form on or within the computer. To avoid damaging the computer, allow sufficient time for the moisture to evaporate before using the computer.
-  **NOTICE:** When taking the computer from low-temperature conditions into a warmer environment or from high-temperature conditions into a cooler environment, allow the computer to acclimate to room temperature before turning on power.
- When you disconnect a cable, pull on its connector or on its strain-relief loop, not on the cable itself. As you pull out the connector, keep it evenly aligned to avoid bending any connector pins. Also, before you connect a cable make sure both connectors are correctly oriented and aligned.
 - Handle components with care. Hold a component such as a memory module by its edges, not its pins.

- When removing a memory module from the system board or disconnecting a peripheral device from the computer, wait 5 seconds after turning off the computer before removing the memory module or disconnecting the device to help avoid possible damage to the system board.
- Clean the display with a soft, clean cloth and commercial window cleaner that does not contain wax or abrasives. Apply the cleaner to the cloth; then stroke the cloth across the display in one direction, moving from the top of the display to the bottom. If the display contains grease or some other contaminant, use isopropyl alcohol instead of commercial window cleaner.
- If your computer gets wet or is damaged, follow the procedures described in “If Your Computer Gets Wet” on page 42 and “If You Drop or Damage Your Computer” on page 43. If, after following these procedures, you confirm that your computer is not operating properly, contact Dell (see page 73).

When Removing or Installing Memory Modules

Before removing or installing memory modules, perform the following steps in the sequence indicated.

 **NOTICE:** The only time you should ever access the inside of your computer is when you are installing memory modules.

 **NOTICE:** Wait 5 seconds after turning off the computer before disconnecting a peripheral device or removing a memory module to help prevent possible damage to the system board.

- 1 Turn off your computer and any attached peripherals.
- 2 Disconnect your computer and peripherals from electrical outlets to reduce the potential for personal injury or shock. Also, disconnect any telephone or telecommunication lines from the computer.
- 3 Remove the main battery from the battery bay and, if necessary, the secondary battery from the media bay.
- 4 Ground yourself by touching the unpainted metal surface of the I/O panel on the back of the computer.

While you work, periodically touch the I/O panel to dissipate any static electricity that might harm internal components.

Protecting Against Electrostatic Discharge

Static electricity can harm electronic components inside your computer. To prevent static damage, discharge static electricity from your body before you touch any of your computer's electronic components, such as a memory module. You can do so by touching an unpainted metal surface on the computer's I/O panel.

As you continue to work inside the computer, periodically touch an I/O connector to remove any static charge your body may have accumulated.

You can also take the following steps to prevent damage from electrostatic discharge (ESD):

- When unpacking a static-sensitive component from its shipping carton, do not remove the component from the antistatic packing material until you are ready to install the component. Just before unwrapping the antistatic packaging, be sure to discharge static electricity from your body.
- When transporting a sensitive component, first place it in an antistatic container or packaging.
- Handle all sensitive components in a static-safe area. If possible, use antistatic floor pads and workbench pads.

The following notice may appear throughout this document to remind you of these precautions:

 **NOTICE:** See "Protecting Against Electrostatic Discharge" in the safety instructions at the front of this guide.

SECTION 1

Setting Up

Connecting a Printer

Turning Off the Computer

Using the Media Bay

Setting Up the Dolby Headphone

Setting Up the APR to Connect to a Network

Connecting a Printer

See the documentation that came with the printer for any recommended preparation procedures, such as:

- Removing the packaging
- Installing the toner or ink cartridge
- Loading paper

Then follow the instructions that came with the printer to connect it to the computer. If no information is provided, see the following sections.

Installing the Printer Driver

Dell installs drivers for some new printers. Click the **Start** button, point to **Settings**, and then click **Printers**. If your printer is listed in the **Printers** window, the printer is ready to use.

If you need to install a printer driver, insert the installation CD into the CD or DVD drive. Then follow the prompts on the screen using the instructions that came with the printer.

If your printer installation CD does not automatically run, click the **Start** button on the Microsoft® Windows® desktop, click **Run**, and type `x:\setup.exe` (where *x* is the letter of your CD or DVD drive [usually drive D]). Then click **OK** and follow the prompts on your screen.

Parallel Printer

- 1 Turn off the computer (see page 18).



NOTICE: Use only a standard IEEE parallel cable measuring 3 m (10 ft) or less to connect the printer to the computer. Use of a nonstandard cable may prevent the printer from working.

- 2 Attach the parallel printer cable to the parallel connector on the computer and tighten the two screws. Attach the cable to the parallel connector on the printer and snap the two clips into the two notches.



HINT: For complete printer driver installation instructions, refer to your printer documentation.

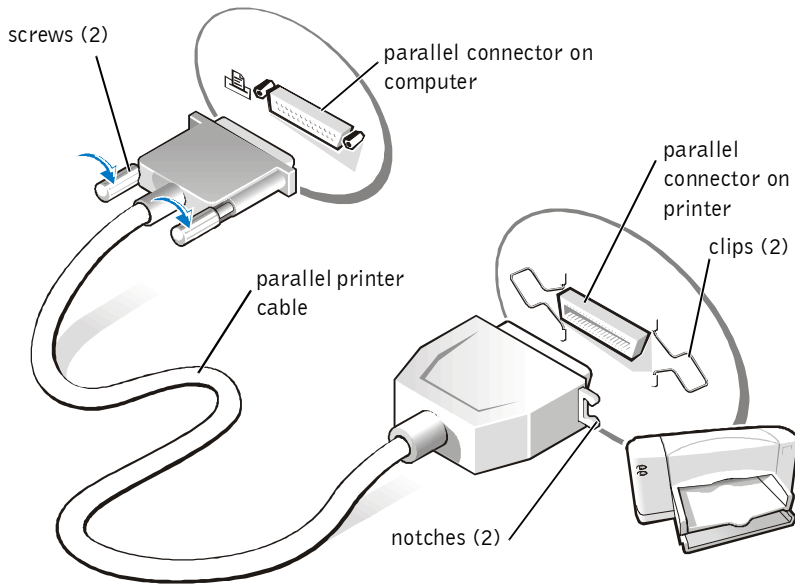

- 3 Turn on the printer and then turn on the computer. If the **Add New Hardware Wizard** window appears, click **Cancel**.
- 4 Install the printer driver if necessary (see page 16).

USB Printer

- 1 Install the printer driver if necessary (see page 16).
- 2 Attach the USB printer cable to the USB connector on the computer and the printer. The USB connectors fit only one way.

 **HINT:** You can connect USB devices while the computer is turned on.

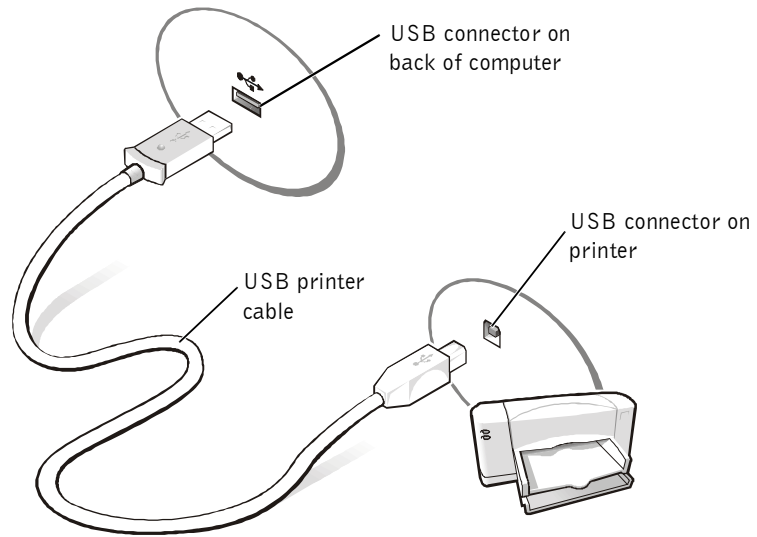

Turning Off the Computer

➔ NOTICE: To prevent data loss, you must perform the Windows shutdown procedure to turn off your computer.

Windows Millennium Edition (Me) and Windows 2000

- 1 Save and close any open files and exit any open programs.
- 2 Click the **Start** button and then click **Shut Down**.
- 3 Click the pull-down menu under **What do you want the computer to do?**.
- 4 Click **Shut down** and then click **OK**.

The computer automatically turns off after the shutdown process finishes.

Using the Media Bay

Dell ships your computer with a floppy drive installed in the media bay. The media bay also supports the following devices:

- CD drive
- CD-RW drive
- DVD drive
- DVD/CD-RW combo drive
- Zip drive
- Second hard drive
- Second battery
- Dell TravelLite™ module



NOTICE: To prevent irreparable damage to the docking connector, do not remove or replace devices while the computer is connected to an advanced port replicator (APR).

Swapping Devices While the Computer Is Turned Off

- 1 Save and close any open files, exit any open programs, and shut down the computer (see page 18).
 - 2 If the computer is connected (docked) to an APR, undock it (see page 55).
 - 3 Close the display and turn the computer over.
 - 4 Slide and hold the latch release, and pull the device out of the media bay.
- NOTICE:** To prevent damage, place devices in a travel case when they are not inserted in the computer. Store devices in a dry, safe place, and avoid placing heavy objects on top of them.

bottom of computer

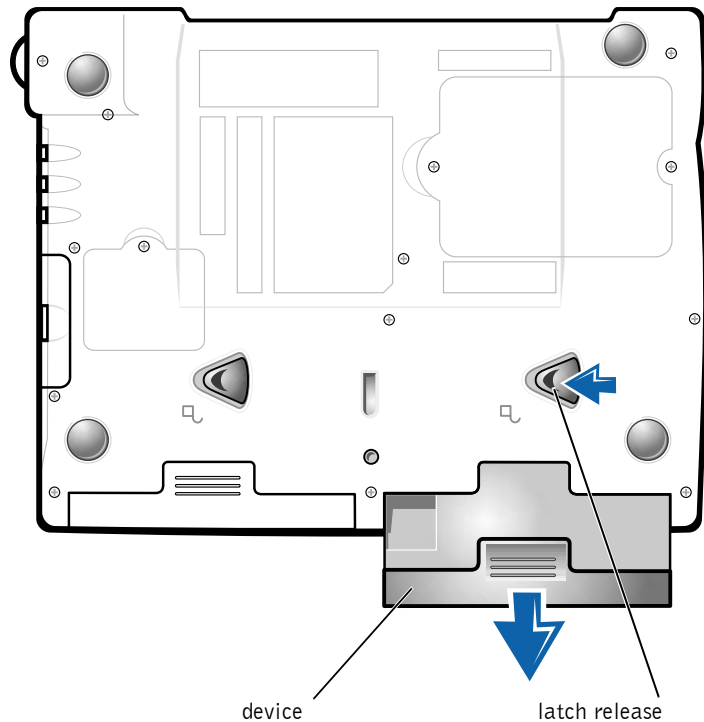

- ➔ **NOTICE:** Insert devices before you dock and turn on the computer.
- 5 Insert the new device into the bay, and push it until you hear a click.
- 6 Turn on the computer.

Swapping Devices While Windows Is Running

- ➔ **NOTICE:** To prevent irreparable damage to the docking connector, do not replace devices while the computer is connected to an APR.

In Microsoft Windows Me

- 1 Right-click the **Softex BayManager** icon on the Microsoft Windows taskbar.
- 2 Click **Remove/Swap**.
- 3 Keep the display open, and tilt the computer back so that you can access the bottom of the computer.
- 4 Slide and hold the latch release, and pull the device out of the media bay.
- 5 Insert the new device into the bay, and push it until you hear a click.
- 6 Click **OK**. Then click **OK** again to close the **Softex BayManager** window.

In Microsoft Windows 2000

- 1 Double-click the **Unplug or Eject Hardware** icon on the Microsoft Windows taskbar.
- 2 Click the device you want to eject and then click **Stop**.
- 3 Click **OK**, and wait until the device you want to eject is cleared from the list of devices in the **Unplug or Eject Hardware** window.
- 4 Keep the display open, and tilt the computer back so that you can access the bottom of the computer.
- 5 Slide and hold the latch release, and pull the device out of the media bay.
- 6 Insert the new device into the bay, and push it until you hear a click.
- 7 When Windows recognizes the new device, click **Close**.

 **HINT:** The Dolby headphone feature is available only if your computer has a DVD drive.

 **HINT:** Icon labels may be visible only when you place the pointer over the icon.

 **HINT:** A network adapter is also referred to as a network interface controller (NIC).

Setting Up the Dolby Headphone

- 1 Double-click the **Intervideo Win DVD** icon on the Windows desktop.
- 2 Click the **Properties** icon.
- 3 Click the **Dolby Headphone** tab.
- 4 Click **Enable Dolby Headphone**.
- 5 Select one of the four options to set the level of surround sound effects. **Option 1** is a baseline stereo option and **Options 2, 3, and 4** are surround sound levels.
- 6 Click **Apply**, and then click **OK** to close the **WinDVD Properties** window.
- 7 Click **Exit**.

Setting Up the APR to Connect to a Network

 **NOTICE:** Do not install a network adapter or a network adapter/modem combination PC Card until you complete the advanced port replicator (APR) setup.

If you purchased the APR with an integrated network adapter, you must first configure the computer to use the APR with a network.

Setting Up the APR for Windows Me

- 1 If the computer is on, shut down the operating system and turn off the computer (see page 18).
- 2 Disconnect all external devices from the APR.
- 3 Connect the AC adapter to the APR and an electrical outlet.
- 4 Insert the computer into the APR.
- 5 Turn on the computer.

The computer automatically detects the network adapter and begins the software installation.

- 6 At the **Add New Hardware Wizard** window, click **Automatic search for a better driver (Recommended)** and then click **Next**.

- 7 Click **Finish** when Windows displays a message that the driver is installed.
- 8 Click **Yes** to restart the computer.
After the computer restarts, Windows modifies settings, creates a **Dock 1** configuration, and then displays a **Setup is complete** message.
- 9 Click **OK**.
- 10 If the **Updated display settings** message appears, click **OK**.
- 11 If necessary, consult your network administrator for instructions on configuring the network adapter settings.

Setting Up the APR for Windows 2000

 **NOTICE:** Do not install the drivers from the CD that is shipped with the APR. The network adapter will not work if they are installed.

- 1 If the computer is on, shut down the operating system and turn off the computer (see page 18).
- 2 Disconnect all external devices from the APR.
- 3 Insert the computer into the APR.
- 4 Attach the network cable and the AC adapter to the APR.
- 5 Turn on the computer.
- 6 Log on as a user with administrative privileges.
- 7 Make sure that **Intel 3Com PCI Ethernet Adapter (10/100)** appears in the **Found New Hardware** window.

Windows 2000 automatically installs the network adapter drivers.

SECTION 2

Solving Problems

Finding Solutions
Accessing Help Files
Power Problems
Start-Up Error Messages
Video and Display Problems
Sound and Speaker Problems
Printer Problems
Modem Problems
Scanner Problems
Touch Pad Problems
External Keyboard Problems
Unexpected Characters
Drive Problems
Network Problems
Windows Error Messages
General Program Problems
Internet Connection Problems
E-Mail Problems
If Your Computer Gets Wet
If You Drop or Damage Your Computer
Resolving Other Technical Problems
Reinstalling Drivers and Utilities
Reinstalling Windows

Finding Solutions

Sometimes it's difficult to figure out where to go for answers. Use this chart to quickly find the answers to your questions.

 **HINT:** If you have a problem with an external device, see the device documentation or contact the manufacturer.

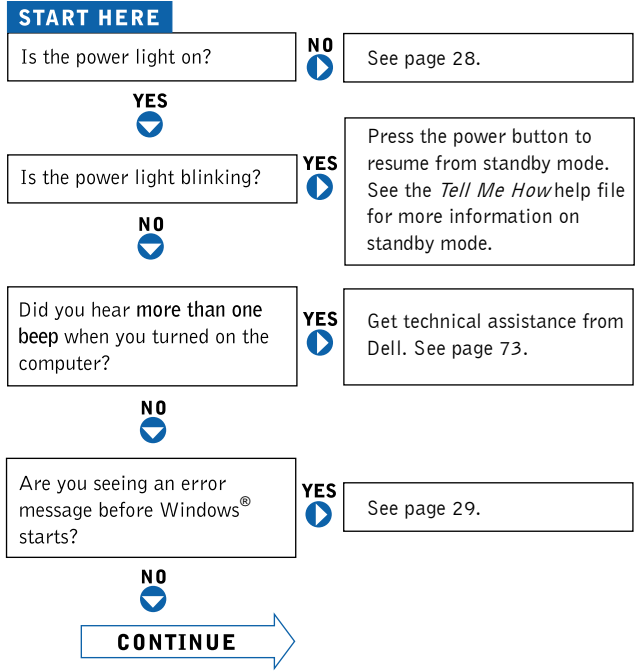

Are you having a problem with...

NO
▶

- ▶ video or the display? **YES** ▶ See page 30.
- ▶ sound or the speakers? **YES** ▶ See page 31.
- ▶ the printer? **YES** ▶ See page 32.
- ▶ the modem? **YES** ▶ See page 33.
- ▶ the scanner? **YES** ▶ See page 34.
- ▶ the touch pad? **YES** ▶ See page 35.
- ▶ the external keyboard? **YES** ▶ See page 35.
- ▶ unexpected characters? **YES** ▶ See page 35.
- ▶ the hard drive or a disk drive? **YES** ▶ See page 36.
- ▶ the network adapter? **YES** ▶ See page 39.
- ▶ Windows error messages? **YES** ▶ See page 39.
- ▶ a program? **YES** ▶ See page 40.
- ▶ the Internet? **YES** ▶ See page 41.
- ▶ your e-mail? **YES** ▶ See page 42.

Are you having some other type of problem?

YES ▶ See page 44.

Accessing Help Files

TO ACCESS THE *TELL ME HOW* HELP FILE

- 1 Click the **Start** button, point to **Programs**—> **User's Guides**, and then click **Tell Me How**.

TO ACCESS *MICROSOFT® WINDOWS 2000 HELP*

- 1 Click the **Start** button and then click **Help**.
- 2 Click the **Search** tab.
- 3 Type a word or phrase that describes your problem and then click **List Topics**.
- 4 Click the topic that describes your problem and then click **Display**.
- 5 Follow the instructions shown on the screen.

TO ACCESS *WINDOWS ME HELP*

- 1 Click the **Start** button and then click **Help**.
- 2 Type a word or phrase that describes your problem in the **Search** box and then click **Go**.
- 3 Click the topic that describes your problem and then click **Display**.
- 4 Follow the instructions shown on the screen.

Power Problems



HINT: See the *Tell Me How* help file for information on standby mode.

CHECK THE POWER LIGHT—When the power light is lit or blinking, the computer has power. If the power light is blinking, the computer is in standby mode—press the power button to resume from standby mode. If the power light is off, press the power button.

CHECK THE BATTERY—If you are using a battery to power your computer, the battery charge may be depleted. Connect the computer to an electrical outlet using the AC adapter, and turn on the computer.

TEST THE ELECTRICAL OUTLET—Ensure that the electrical outlet is working by testing it with another device, such as a lamp.

CHECK THE AC ADAPTER— Be sure that the power cable is firmly inserted into the electrical outlet and the green light on the AC adapter is on.

CONNECT THE COMPUTER DIRECTLY TO AN ELECTRICAL OUTLET—

Bypass power protection devices, power strips, and the extension cable to verify that the computer turns on.

CHECK FOR INTERFERENCE— Electrical appliances on the same circuit or operating near the computer can cause interference. Other causes of interference: power extension cables, too many devices on a power strip, or multiple power strips connected to the same electrical outlet.

ADJUST THE POWER PROPERTIES— See the *Tell Me How* help file or search for the keyword *standby* in *Windows Help*. To access help files, see page 28.

RESET THE MEMORY MODULES— If your computer power light turns on but the display remains blank, you may need to reseat the memory modules (see page 57).

Start-Up Error Messages

OPERATING SYSTEM NOT FOUND— Contact Dell for technical assistance (see page 73).

INSERT BOOTABLE MEDIA— The operating system is trying to boot to a nonbootable floppy disk or CD. Insert a bootable floppy disk or CD.

NON-SYSTEM DISK ERROR— A floppy disk is in the floppy drive. Remove the floppy disk and restart the computer.

Video and Display Problems

If the display is blank

CHECK THE POWER LIGHT—When the power light is blinking, the computer has power. If the power light is blinking, the computer is in standby mode—press the power button to exit standby mode. If the power light is off, press the power button.

CHECK THE BATTERY—If you are using a battery to power your computer, the battery charge may be depleted. Connect the computer to an electrical outlet using the AC adapter, and turn on the computer.

TEST THE ELECTRICAL OUTLET—Ensure that the electrical outlet is working by testing it with another device, such as a lamp.

CHECK THE AC ADAPTER—Be sure that the power cable is firmly inserted into the electrical outlet and the green light on the AC adapter is on.

ADJUST THE POWER PROPERTIES—Search for the keyword *standby* in *Windows Help*. To access help files, see page 28.

If the display is difficult to read

ADJUST THE BRIGHTNESS—See the *Tell Me How* help file (see page 28) for instructions on adjusting the brightness.

MOVE THE SUBWOOFER AWAY FROM THE COMPUTER OR MONITOR—If your external speaker system includes a subwoofer, ensure that the subwoofer is at least 60 cm (2 ft) away from the computer or external monitor.

ELIMINATE POSSIBLE INTERFERENCE—Turn off nearby fans, fluorescent lights, or halogen lamps to check for interference.

ROTATE THE COMPUTER TO FACE A DIFFERENT DIRECTION—Eliminate sunlight glare, which can cause poor picture quality.

RESTORE THE RECOMMENDED SETTINGS—Restore the original resolution and refresh rate settings. See the *Tell Me How* help file for instructions. To access help files, see page 28.

ADJUST THE WINDOWS DISPLAY SETTINGS—

- 1 Click the **Start** button, point to **Settings**, and then click **Control Panel**.
- 2 Double-click the **Display** icon and then click the **Settings** tab.
- 3 Try different settings for **Colors** and **Screen area**.

Sound and Speaker Problems

Integrated Speakers

ADJUST THE WINDOWS VOLUME CONTROL—Double-click the yellow speaker icon in the lower-right corner of your screen. Be sure that the volume is turned up and that the sound is not muted.

CHECK THE VOLUME CONTROL BUTTONS—Press both volume control buttons simultaneously or press <Fn><End> to disable (mute) or reenable the integrated speakers.

REINSTALL THE SOUND (AUDIO) DRIVER—See page 44.

External Speakers

VERIFY THE SPEAKER CABLE CONNECTIONS—Ensure that the speakers are connected as shown on the setup diagram supplied with the speakers.

TEST THE ELECTRICAL OUTLET—Ensure that the electrical outlet is working by testing it with another device, such as a lamp.

ENSURE THAT THE SPEAKERS ARE TURNED ON—See the setup diagram supplied with the speakers.

 **HINT:** The volume control in some MP3 players overrides the Windows volume setting. If you have been listening to MP3 songs, make sure that you did not turn the player volume down or off.

ADJUST THE SPEAKER CONTROLS— Adjust the volume, bass, or treble controls to eliminate distortion.

ADJUST THE WINDOWS VOLUME CONTROL— Double-click the yellow speaker icon in the lower-right corner of your screen. Be sure that the volume is turned up and that the sound is not muted.

TEST THE SPEAKERS— Plug the speaker audio cable into the headphone connector on the side of the computer. Ensure that the headphone volume control is turned up. Play a music CD.

RUN THE SPEAKER SELF-TEST— Some speaker systems have a self-test button on the subwoofer. See the speaker documentation for self-test instructions.

MOVE THE SUBWOOFER AWAY FROM THE COMPUTER OR MONITOR— If your external speaker system includes a subwoofer, ensure that the subwoofer is at least 60 cm (2 ft) away from the computer or external monitor.

ELIMINATE POSSIBLE INTERFERENCE— Turn off nearby fans, fluorescent lights, or halogen lamps to check for interference.

REINSTALL THE SOUND (AUDIO) DRIVER— See page 44.

Printer Problems

If you cannot print to a parallel port printer

VERIFY THE PRINTER CABLE CONNECTIONS— Ensure that the printer cable is connected as described on page 16.

TEST THE ELECTRICAL OUTLET— Ensure that the electrical outlet is working by testing it with another device, such as a lamp.

ENSURE THAT THE PRINTER IS TURNED ON— See the documentation supplied with the printer.

VERIFY THAT THE PRINTER IS RECOGNIZED BY WINDOWS

- 1 Click the **Start** button, point to **Settings**, and then click **Printers**.
If the printer is listed, right-click the printer icon, click **Properties**, and then select the **Details** tab (**Ports** tab in Windows 2000).
- 2 Ensure that the **Print to the following port:** setting is **LPT1 (Printer Port)**.

REINSTALL THE PRINTER DRIVER— See page 16.

If you cannot print to a USB printer

VERIFY THE PRINTER CABLE CONNECTIONS— Ensure that the printer cable is connected as described on page 17.

TEST THE ELECTRICAL OUTLET— Ensure that the electrical outlet is working by testing it with another device, such as a lamp.

ENSURE THAT THE PRINTER IS TURNED ON— See the documentation supplied with the printer.

VERIFY THAT THE PRINTER IS RECOGNIZED BY WINDOWS—

- 1 Click the **Start** button, point to **Settings**, and then click **Printers**.
If the printer is listed, right-click the printer icon, click **Properties**, and then select the **Details** tab (**Ports** tab in Windows 2000).
- 2 Ensure that the **Print to the following port:** setting is **USB**.

REINSTALL THE PRINTER DRIVER— See page 16.

Modem Problems

-  **NOTICE:** Connect the modem to an analog telephone wall jack only. Connecting the modem to a digital telephone network damages the modem.

CHECK THE TELEPHONE JACK— Disconnect the telephone line from the modem and connect it to a telephone. Listen for a dial tone.

CONNECT THE MODEM DIRECTLY TO THE TELEPHONE WALL JACK— If you have other telephone devices sharing the line, such as an answering machine, fax machine, surge protector, or line splitter, then bypass them and connect the modem directly to the telephone wall jack with the telephone line.

CHECK THE CONNECTION— Verify that the telephone line is connected to the modem.

CHECK THE TELEPHONE LINE— Try using a different telephone line. If you are using a line that is 3 m (10 ft) or more in length, try a shorter one.

VERIFY THAT THE MODEM IS COMMUNICATING WITH WINDOWS

- 1** Click the **Start** button, point to **Settings**, and click **Control Panel**. (In Windows 2000, double-click **Control Panel**.)
- 2** In the **Control Panel** window, double-click **Modems**.
If there are multiple entries for the same modem or modems listed that are not installed, delete the entries and restart the computer.
- 3** Click the **Diagnostics** tab.
- 4** Click the COM port for your modem.
- 5** Click **More Info** to verify that the modem is communicating with Windows.
If all commands receive responses, the modem is operating properly.

Scanner Problems

CHECK THE POWER CABLE CONNECTION— Ensure that the scanner power cable is firmly connected to a working electrical power source and that the scanner is turned on.

CHECK THE SCANNER CABLE CONNECTION— Ensure that the scanner cable is firmly connected to the computer and to the scanner.

UNLOCK THE SCANNER— Ensure that your scanner is unlocked if it has a locking tab or button.

REINSTALL THE SCANNER DRIVER— See the scanner documentation for instructions.

Touch Pad Problems

CHECK THE TOUCH PAD SETTINGS— Click the **Start** button, point to **Settings**, click **Control Panel**, and then double-click the **Mouse** icon. Try adjusting the settings.

External Keyboard Problems

DISCONNECT THE KEYBOARD CABLE— Shut down the computer (see page 18). Disconnect the keyboard cable and check the cable connector for bent or broken pins.

Unexpected Characters

DISABLE THE NUMERIC KEYPAD— Press the <Num Lk> key to disable the numeric keypad. Verify that the numbers lock light is not lit.



HINT: If you connect an external PS/2 keyboard or keypad to the computer, the numeric keypad on the integrated keyboard is disabled. If you connect an external USB keyboard or keypad to the computer, the numeric keypad remains enabled.

Drive Problems

HINT: For information on saving files to a floppy disk, see the *Tell Me How* help file (see page 28).

If you cannot save a file to a floppy disk

ENSURE THAT WINDOWS RECOGNIZES THE DRIVE— Double-click the My Computer icon. If the floppy drive is not listed, perform a full scan with your antivirus software to check for and remove viruses. Viruses can sometimes prevent Windows from recognizing the drive.

CANNOT SAVE FILES TO A FLOPPY DISK— Ensure that the floppy disk is not full or write-protected (locked). See the following illustration.

TEST THE DRIVE WITH ANOTHER FLOPPY DISK— Insert another floppy disk to eliminate the possibility that the original floppy disk is defective.

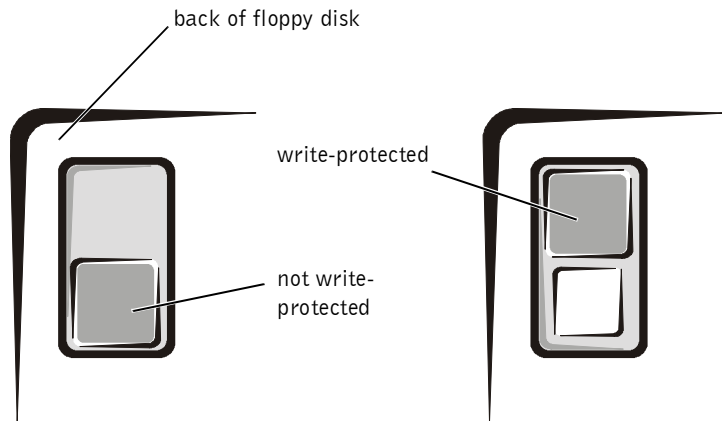

If you cannot play a music CD or install a program from a CD

ENSURE THAT WINDOWS RECOGNIZES THE DRIVE— Double-click the **My Computer** icon. If the CD drive is not listed, perform a full scan with your antivirus software to check for and remove viruses. Viruses can sometimes prevent Windows from recognizing the drive.

TEST THE DRIVE WITH ANOTHER CD— Insert another CD to eliminate the possibility that the original CD is defective.

CLEAN THE DISC— See the *Tell Me How* help file for instructions. To access help files, see page 28.

ADJUST THE WINDOWS VOLUME CONTROL— Double-click the yellow speaker icon in the lower-right corner of your screen. Be sure that the volume is turned up and that the sound is not muted.

IF YOU HAVE ONE CD IN THE FIXED OPTICAL DRIVE AND ONE CD IN THE MEDIA BAY— To identify which CD is not playing:

For Windows 2000, double-click the **Softex BayManager** icon on the taskbar. Then click the **Storage Devices** tab and click **Computer** to see if the device is listed. Click **OK** if both devices are listed. If only one device is listed, remove the CD from the listed bay and ensure that Windows recognizes the drive.

For Windows Me, double-click the **My Computer** icon on your desktop. Then double-click the drive letter of the device the you are verifying.



HINT: High-speed CD drive vibration is normal and may cause noise. This noise does not indicate a defect in the drive or the CD.



HINT: Because of different worldwide file types, not all DVD titles work in all DVD drives.

If you cannot play a DVD movie

ENSURE THAT WINDOWS RECOGNIZES THE DRIVE— Double-click the **My Computer** icon. If the DVD drive is not listed, perform a full scan with your antivirus software to check for and remove viruses. Viruses can sometimes prevent Windows from recognizing the drive.

TEST THE DRIVE WITH ANOTHER DVD— Insert another DVD to eliminate the possibility that the original DVD is defective.

CLEAN THE DISC— See the *Tell Me How* help file for instructions. To access, help files, see page 28.

If the CD-RW drive stops writing



HINT: If you must disable standby mode to write to a CD-RW drive, remember to enable standby mode again when you finish writing the CD.

DISABLE STANDBY MODE IN WINDOWS BEFORE WRITING TO A CD-RW DISK— Search for the keyword *standby* in *Windows Help*. To access help files, see page 28.

CHANGE THE WRITE SPEED TO A SLOWER RATE— The CD-RW drive must receive a steady stream of data when writing. If the stream is interrupted, an error occurs. Closing all programs before writing to the CD-RW may also alleviate the problem.

If you have a hard drive problem

CHECK THE HARD DRIVE FOR ERRORS

Windows Me:

Click the **Start** button, point to **Programs**—> **Accessories**—> **System Tools**, and then click **ScanDisk**.

Windows 2000:

- 1 Double-click the **My Computer** icon.
- 2 Right-click the **Local Disk** icon and then click **Properties**.
- 3 Click the **Tools** tab.
- 4 Click **Check Now**.

Network Problems

CHECK THE NETWORK CABLE CONNECTOR—Ensure that the network cable connector is firmly connected to the connector on the computer and the network wall jack.

CHECK THE NETWORK LIGHTS ON THE NETWORK CONNECTOR—Green indicates that the network connection is active. If the status light is not green, try replacing the network cable. Amber indicates that the network card driver is loaded and the card is detecting activity.

RESTART THE COMPUTER—Try to log on to the network again.

CONTACT YOUR NETWORK ADMINISTRATOR—Verify that your network settings are correct and that the network is functioning.

Windows Error Messages

X:\ IS NOT ACCESSIBLE. THE DEVICE IS NOT READY—Insert a disk into the drive and try again.

A FILENAME CANNOT CONTAIN ANY OF THE FOLLOWING CHARACTERS: \ / : * ? " < > |—Do not use these characters in filenames.

NOT ENOUGH MEMORY OR RESOURCES. CLOSE SOME PROGRAMS AND TRY AGAIN—You have too many programs open. Close all windows and open the program that you want to use.

THE FILE BEING COPIED IS TOO LARGE FOR THE DESTINATION DRIVE—The file that you are trying to copy is too large to fit on the disk, or the disk is too full. Try copying the file to a different disk or use a larger capacity disk.

A REQUIRED .DLL FILE WAS NOT FOUND—The program that you are trying to open is missing an essential file. To remove and then reinstall the program:

Windows Me:

- 1 Click the **Start** button, point to **Settings**, and then click **Control Panel**.
- 2 Double-click the **Add/Remove Programs** icon.
- 3 Select the program that you want to remove.
- 4 Click **Add/Remove** and follow the prompts on the screen.
- 5 See the program documentation for installation instructions.

Windows 2000:

- 1 Click the **Start** button, point to **Settings**, and then double-click **Control Panel**.
- 2 Double-click the **Add/Remove Programs** icon.
- 3 Select the program that you want to remove.
- 4 Click **Change/Remove** and follow the prompts on the screen.
- 5 See the program documentation for installation instructions.

General Program Problems

A program crashes

SEE THE SOFTWARE DOCUMENTATION—Many software manufacturers maintain websites with information that may help you to solve the problem.

A program stops responding

PRESS <CTRL> <ALT> **—In the **Close Program window, select the program that is no longer responding. Then click **End Task**.

A solid blue screen appears

TURN THE COMPUTER OFF— If the computer does not respond to a keystroke or a proper shutdown (see page 18), press the power button until the computer turns off. Press the power button again to restart the computer. The solid blue screen appears because you were not able to perform a proper Windows shutdown. ScanDisk will automatically run during the start-up process. Follow the instructions on the screen.

Internet Connection Problems

REVIEW “MODEM PROBLEMS”— See page 33.

TURN OFF CALL WAITING (CATCH-PHONE)— See your telephone directory for instructions on deactivating this feature. Then adjust the dial-up networking connection properties:

- 1 Click the **Start** button, point to **Settings**, and then click **Control Panel**.
- 2 Double-click the **Modems** icon.
- 3 In the **Modems Properties** window, click **Dialing Properties**.
- 4 Ensure that **To disable call waiting, dial:** is checked, and then select the proper code according to the information in your telephone directory.
- 5 Click **Apply** and then click **OK**.
- 6 Close the **Modems Properties** window.
- 7 Close the **Control Panel** window.

E-Mail Problems

ENSURE THAT YOU ARE CONNECTED TO THE INTERNET—With the Outlook Express e-mail program open, click **File**. If **Work Offline** has a check next to it, click the check to remove it and connect to the Internet.

If Your Computer Gets Wet



CAUTION: Perform this procedure only after you are certain that it is safe to do so. If the computer is connected to an electrical outlet, Dell recommends that you turn off AC power at the circuit breaker before attempting to remove the power cables from the electrical outlet. Use the utmost caution when removing wet cables from a live power source.

- 1 Turn off the computer (see page 18), disconnect the AC adapter from the computer, and disconnect the AC adapter from the electrical outlet.
- 2 Turn off any attached external devices, and disconnect them from their power sources and then from the computer.
- 3 Ground yourself by touching one of the metal connectors on the back of the computer.
- 4 Remove the media bay device (see page 19) and any installed PC Cards, and put them in a safe place to dry.
- 5 Remove the battery.
- 6 Wipe off the battery and put it in a safe place to dry.
- 7 Remove the hard drive (see page 62).
- 8 Remove the memory modules (see page 57).
- 9 Open the display and place the computer right-side up across two books or similar props to let air circulate all around it. Let the computer dry for at least 24 hours in a dry area at room temperature.



NOTICE: Do not use artificial means, such as a hair dryer or a fan, to speed up the drying process.



CAUTION: To help prevent electrical shock, verify that the computer is thoroughly dry before continuing with the remainder of this procedure.

- 10** Ground yourself by touching one of the metal connectors on the back of the computer.
- 11** Replace the memory modules, the memory module cover, and the screw (see page 57).
- 12** Replace the hard drive (see page 62).
- 13** Replace the media bay device (see page 19) and any PC Cards you removed.
- 14** Replace the battery.
- 15** Turn on the computer and verify that it is working properly.

If the computer does not start, or if you cannot identify the damaged components, contact Dell for technical assistance (see page 73).

If You Drop or Damage Your Computer

- 1** Save and close any open files, exit any open programs, and shut down the computer (see page 18).
- 2** Disconnect the AC adapter from the computer, and disconnect the AC adapter from the electrical outlet.
- 3** Turn off any attached external devices, and disconnect them from their power sources and then from the computer.
- 4** Remove and reinstall the battery.
- 5** Turn on the computer.

If the computer does not turn on, or if you cannot identify the damaged components, contact Dell for technical assistance (see page 73).

Resolving Other Technical Problems

GO TO THE DELL SUPPORT WEBSITE— Go to <http://support.dell.com> for help with general usage, installation, and troubleshooting questions.

E-MAIL DELL— Go to <http://support.dell.com> and then click **E-Mail Dell** in the **Communicate** list. Send an e-mail message to Dell about your problem; you can expect to receive an e-mail message from Dell within hours.

CALL DELL— If you cannot solve your problem using the Dell support website or e-mail service, call Dell for technical assistance (see page 73).

Reinstalling Drivers and Utilities

The Dell *Drivers and Utilities* CD for your computer contains drivers for operating systems that may not be on your computer. Verify that the driver you are loading is under your operating system subdirectory.

You can also access and download new drivers, system tools, and documentation from Dell's technical support page at <http://support.dell.com>. For more information on using the operating system installed on your computer by Dell, see the operating system user's guide that came with your computer.



NOTICE: Before you reinstall drivers, make sure that your computer is undocked.

To install a driver or utility from your *Drivers and Utilities* CD, perform the following steps:

- 1 Save your work in all open programs.
- 2 Insert your *Drivers and Utilities* CD into the CD or DVD drive.
In most cases, the CD should start running automatically. If it does not, start Microsoft® Windows® Explorer, click your CD drive directory to display the CD contents, and then click the **Start.htm** file.
- 3 Click a language button to select your preferred user interface language.

The **System Software** screen appears, displaying a list of operating systems (**Software by Operating System**) and an **All Software** category.



- 4 Under **Software by Operating System**, click your operating system to display a list of drivers, a **Utilities** subdirectory, and a **Documentation** subdirectory.
- 5 Click the type of driver (for example, **Audio**) or the utility you want to install.

A link appears for the specific driver or utility used by your computer.
- 6 Click the link to display the **Languages** screen.
- 7 Click your preferred language for the driver or utility (if available) or click **Multiple**.
- 8 At the driver information screen, do one of the following:
 - Click the **Install** button (if present) to start the automatic installation. At the dialog box, select **Run this program from its current location** and then follow the screen prompts to complete the installation.
 - If no **Install** button is present, automatic installation is not an option. Click the **Extract** button to extract the driver files to your hard drive. Click **Run this program from its current location** in the next dialog box. Follow the instructions in the **Readme** file that is included with the drivers.

 **NOTICE:** If instructed to navigate to the driver files, click the CD directory on the driver information screen to display the files associated with that driver.

Reinstalling Windows

Reinstalling Windows Me

-  **NOTICE:** The *Operating System* CD provides options for reinstalling your Windows Me operating system. The options can potentially overwrite files installed by Dell and possibly affect programs installed on your hard drive. Therefore, Dell does not recommend that you reinstall your operating system unless instructed to do so by a Dell technical support representative.
-  **NOTICE:** To prevent conflicts with Windows Me, you must disable any virus protection software installed on your computer before you reinstall Windows.
- 1 Turn on the computer, and enter the system setup program as directed by a Dell technical support representative.

 **HINT:** For detailed information on installing specific drivers and utilities for your computer, see Dell's support website at <http://support.dell.com>.

- 2 In the system setup program **Boot** menu, change the boot sequence so that the CD or DVD drive boots first as directed by a Dell technical support representative. Then place the *Operating System* CD in the CD or DVD drive and close the drive tray.
- 3 Exit the system setup program.
- 4 At the **Welcome** window, click **OK**.
- 5 Double-click **Refresh Windows OS**.
- 6 Click **OK**.
- 7 Click **OK** again.
- 8 Remove the *Operating System* CD from the CD or DVD drive, and click **OK** to restart your computer.

The **Getting ready to run Windows for the first time** window appears.

- 9 If the mouse tutorial starts, press <Esc> to exit and then press <y>.
- 10 Click the regional setting closest to where you live, and then click **Next**.
- 11 Click the graphic that matches your keyboard layout, and then click **Next**.
- 12 In the **User Information** window, type your name and, if applicable, company name, and then click **Next**.

The **Name** field must be completed; the **Company Name** field is optional.

The **License Agreement** window appears.

- 13 Click **I accept the Agreement**, and then click **Next**.
- 14 Type the Windows product key in the fields provided, and then click **Next**.

The product key is the bar code number found on the Microsoft Windows label, which is located on the computer.

- 15 When the **Start Wizard** window appears, click **Finish**.

The **Enter Windows Password** window appears. To continue without creating a Windows user name and password, click **OK**. Otherwise, type your user name and password in the appropriate fields, and then click **OK**.

- 16 If the **Date/Time Properties** window appears, adjust the date and time properties, click **Apply**, and then click **OK**.
Windows updates the system settings and restarts your computer.
- 17 If you created a Windows user name and password, type your password and click **OK**.
- 18 Reinstall the appropriate drivers (see page 44).
- 19 Reenable your virus protection software.

Reinstalling Windows 2000

- 1 Insert the *Operating System* CD into the CD or DVD drive.
- 2 Shut down the computer (see page 18).
- 3 Turn on the computer.
- 4 Press any key when the `Press any key to boot from CD` message appears on the screen.
- 5 When the **Windows 2000 Setup** window appears, ensure that the **To setup Win2000 now**, press **ENTER** option is highlighted. Then press <Enter>.
- 6 Read the information in the **License Agreement** window, and then press <F8> to continue.
- 7 When the **Windows 2000 Professional Setup** window appears, press the arrow keys to select the Windows 2000 partition option that you want. To continue, press the key specified in the partition option that you chose.
- 8 When the **Windows 2000 Professional Setup** window reappears, press the arrow keys to select the type of filing system that you want Windows 2000 to use, and then press <Enter>.
- 9 Press <Enter> again to restart your computer.
- 10 Click **Next** when the **Welcome to the Windows 2000 Setup Wizard** window appears.
- 11 When the **Regional Settings** window appears, select the settings for your locale, and then click **Next**.
- 12 Enter your name and organization in the **Personalize Your Software** window, and then click **Next**.

- 13** When prompted, enter the Windows product key, which is printed on the Microsoft label on your computer. Then click **Next**.
- 14** When the **Computer Name and Administrator Password** window appears, enter a name for your computer and a password, if desired. Then click **Next**.
- 15** Enter the date and time in the **Date and Time Settings** window, and then click **Next**.

Windows 2000 begins to install its components and configure the computer.

- 16** When the **Completing the Windows 2000 Setup Wizard** window appears, remove the CD from the drive, and then click **Finish**. The computer automatically restarts.

 **NOTICE:** Make sure that you reinstall the Intel® Chip Set Update Utility driver *before* you reinstall any other drivers.

Enabling Hibernate Support

- 1** Click the **Start** button, point to **Settings**, and double-click **Control Panel**.
- 2** Double-click the **Power Management** icon.
- 3** Click the **Hibernate** tab.
- 4** Ensure that **Enable hibernate support** is selected, and click **Apply**.
- 5** Click **OK** to close the **Control Panel**.

SECTION 3

Adding Parts

Replacing the Palm Rests

Using the Advanced Port Replicator

Adding Memory

Installing a Mini PCI Card

Replacing a Hard Drive

Replacing the Palm Rests

- 1 Save and close any open files, exit any open programs, and shut down the computer (see page 18).
- 2 If the computer is connected (docked) to an advanced port replicator (APR), undock it (see page 55).
- 3 Keep the display open, and tilt the computer back so that you can access the bottom of the computer.
- 4 Slide and hold the latch release on the left side, and remove any device installed in the media bay.
- 5 Slide and hold the latch release on the right side, and remove any battery installed in the battery bay.
- 6 Locate the indentation under each palm rest, place your thumbs on the indentation, and push to release the palm rests.

bottom of computer

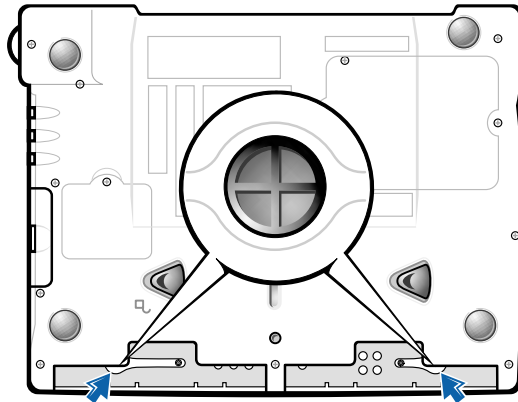

- 7 Remove the palm rests.
- 8 To replace the palm rests, insert the tabs on the edge of the palm rest into the slots and then press down until you hear a click.
Repeat the process on each side.

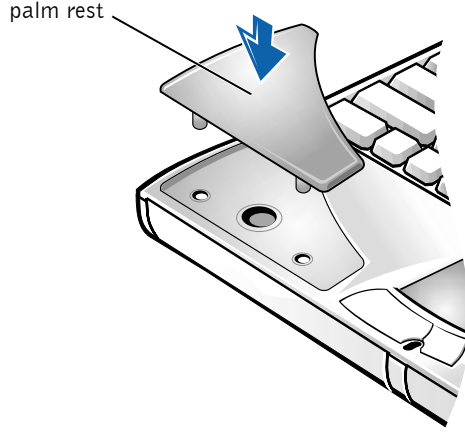

Using the Advanced Port Replicator

The advanced port replicator (APR) integrates your computer into a desktop environment. The APR includes a network adapter to connect your computer to a network.

NOTICE: Do not attempt to lift the computer while it is connected to the APR. Doing so will damage the docking connector.

Connecting External Devices to the APR





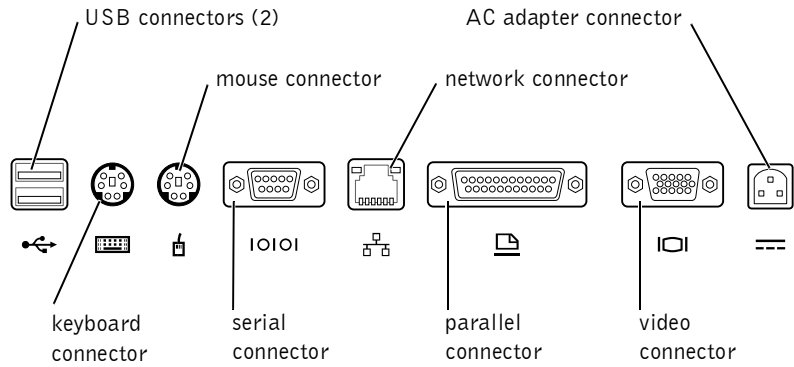

- 1 See the following illustrations for connector locations.
- 2 Connect the external devices to an electrical outlet, if applicable.

The I/O connectors on the back and side of the APR duplicate the primary connectors on the back and side of your computer.

HINT: If you receive a BIOS upgrade floppy disk with your APR, use the disk to upgrade the BIOS before you use the APR.

HINT: If the cable connector from the external device has thumbscrews, be sure to tighten them to ensure a proper connection.



Connector Icon	Connector Description
	Connect one or two USB devices, such as a USB mouse.
	Connect a PS/2-style keyboard or numeric keypad.
	Connect a PS/2-compatible mouse.
10101	Connect a serial device, such as a serial mouse or digital camera.
	Connect a network interface cable.
	Connect a parallel device, such as a printer.
	Connect an external monitor.
	Connect the AC adapter.

The audio line-out connector is on the side of the APR.

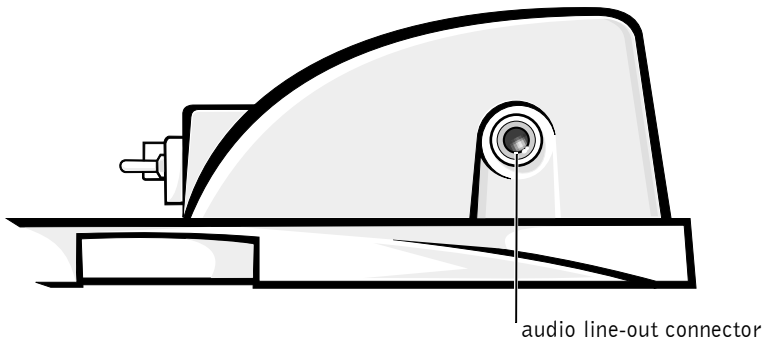

APR Controls and Indicators

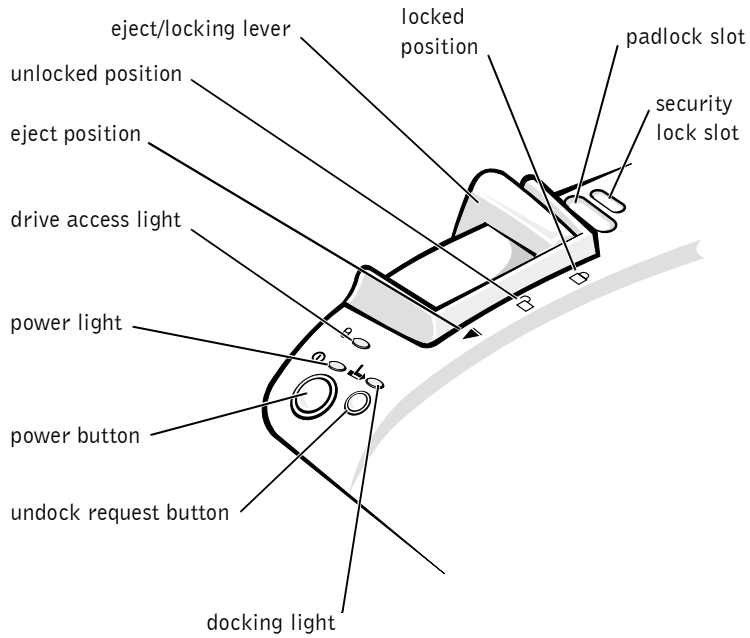



HINT: The infrared sensor does not function when the computer is connected to the APR.

Docking the Computer

➡ **NOTICE:** Before you initially connect your computer to the APR, you must complete the operating system setup. When you see the Windows® desktop on your screen, the operating system setup is complete.

You *dock* your computer when you connect it to an APR. You must connect the AC adapter to the APR before you dock and turn on the computer. The AC adapter powers the APR and the computer at the same time. Any battery installed in the computer charges while you use the APR.

➡ **NOTICE:** Always use the Dell™ AC adapter that came with the APR. If you use any other commercially available AC adapter—or the AC adapter from other Dell computers—you may damage the APR or the computer.

- 1 Save and close any open files, exit any open programs, and shut down the computer (see page 18).
- 2 Disconnect any external devices, and remove any PC Cards from the computer.
- 3 Connect the AC adapter to the connector on the APR, and connect the AC power cable to an electrical outlet.
- 4 Horizontally center the computer on the APR base, with the back of the computer facing the APR docking connector.
- 5 Slide the computer toward the connector until you feel the grooves on the bottom of the computer engage with the alignment rails.

➡ **NOTICE:** If you attempt to push the computer all the way into the APR without engaging the alignment rails, you may irreparably damage the docking connector on the computer. If you have a monitor stand installed, you will not be able to see the alignment rails or the docking connector.

- 6 Gently push the computer forward until the docking connector is fully engaged.
- 7 Slide the eject/locking lever towards the back of the APR to the locked position.

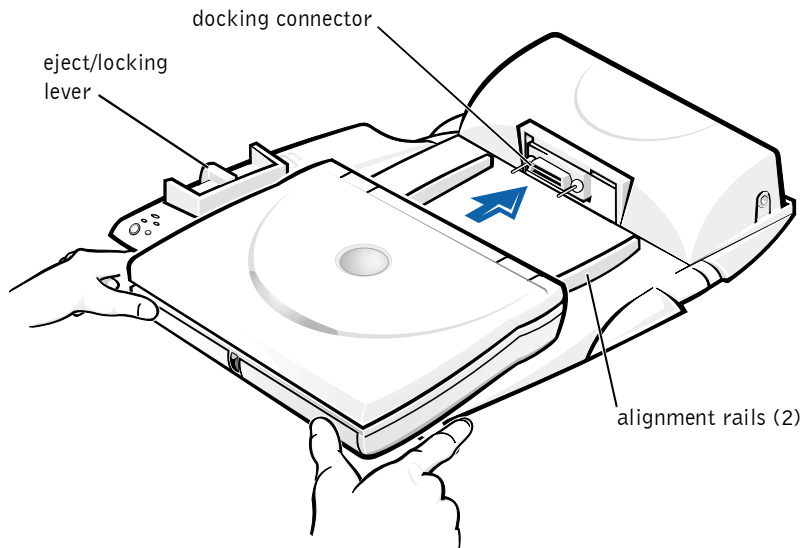

Undocking the Computer

➔ **NOTICE:** If you do not have a charged battery installed in the computer when you undock the computer, you may lose unsaved data.

➔ **NOTICE:** If you do not use correct undocking procedures, you may lose data and the computer may not restart.

- 1 Save and close any open files and exit any open programs.
- 2 Perform one of the following procedures:
 - Click the **Start** button, and then click **Eject PC**.
After a few seconds, the computer power light turns off.
 - Press the undock request button on the APR.
After a few seconds, the green docking light turns off.
- 3 Slide the eject/locking lever on the left side of the APR to the eject position to undock the computer.

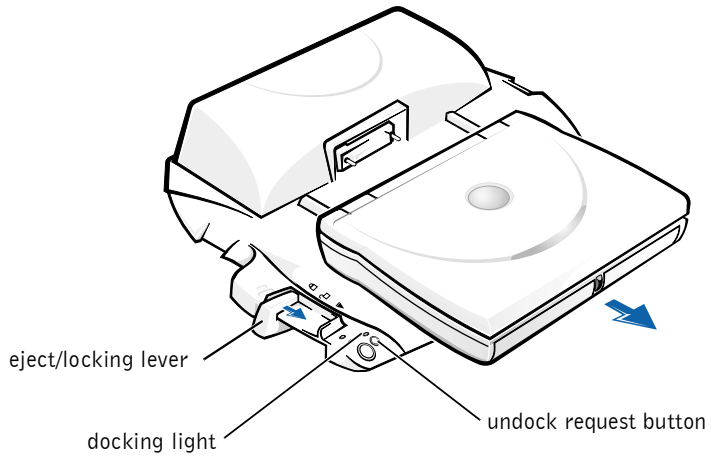

HINT: Be sure that the back legs on the monitor stand engage the slots on either side of the APR base.

Monitor Stand

NOTICE: The stand supports monitors that weigh up to 45.3 kg (100 lb). Heavier monitors may damage the stand, computer, and APR.

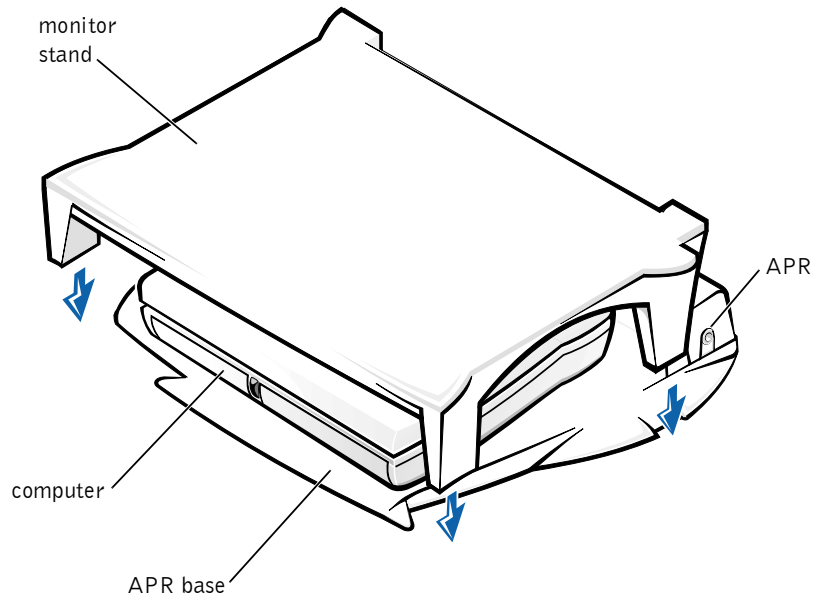

Adding Memory

You can increase your computer memory by installing memory modules on the system board. See page 67 for information on the type of memory supported by your computer.

Your computer has two memory module connectors. All Dell memory modules designed for your computer can be installed in either connector.

CAUTION: Before working inside your computer, read the “Safety and EMC Instructions: Portable Computers” at the front of this guide (see page 7).

NOTICE: Do not install or remove a memory module when the computer is turned on, in standby mode, or in hibernate mode.

- 1 Save and close any open files, exit any open programs, and shut down the computer (see page 18).
- 2 Remove all installed batteries and disconnect external devices.
- 3 Disconnect the AC adapter cable from the computer.
- 4 Ground yourself by touching a metal connector on the back of the computer.
- 5 Turn the computer over, remove the screw located next to the K/M icon, and lift up the memory module cover.

HINT: Memory modules purchased from Dell are covered under your computer warranty.

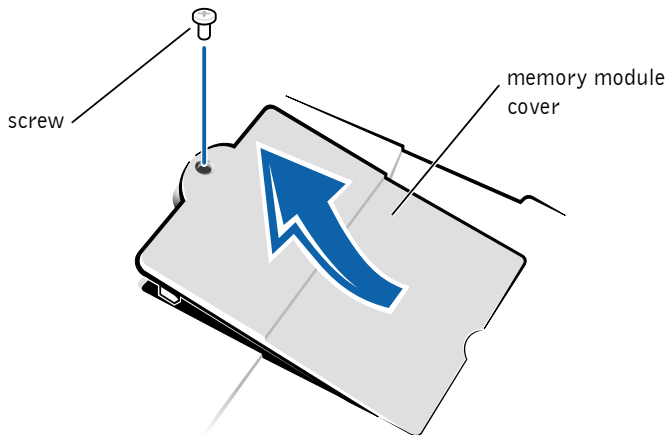

➡ **NOTICE:** To prevent damage to the computer, do not use tools to spread the inner metal tabs of the connector when you are installing or removing a memory module.

6 If you are replacing a memory module, you must remove the existing module:

- a Use your fingernails to carefully spread apart the inner metal tabs of the memory module connector.

The module should pop up.

- b Lift the memory module away from the connector.

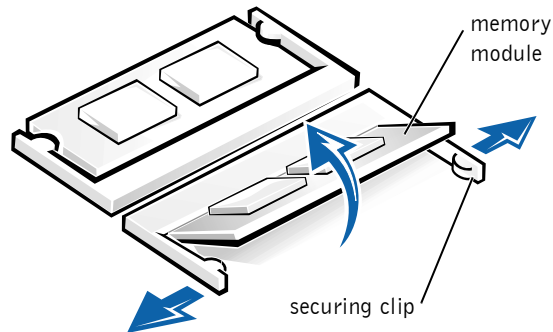

7 Install the memory module:

- a Align the notch in the module with the slot in the center of the connector.
- b Slide the edge of the module firmly into the connector, and rotate the module down until you hear a click.

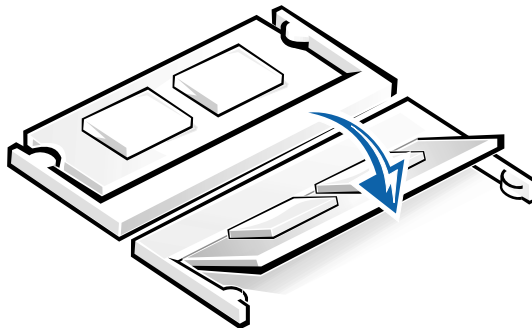

 **HINT:** If the memory module is not installed properly, the computer will not boot. No error message indicates this failure.

- ➔ NOTICE:** If you need to install memory modules in both connectors, install a memory module in the connector labeled “JDIM (DIMMA)” before you install a module in the connector labeled “JDIM2 (DIMMB).”

- 8** Replace the cover and screw.

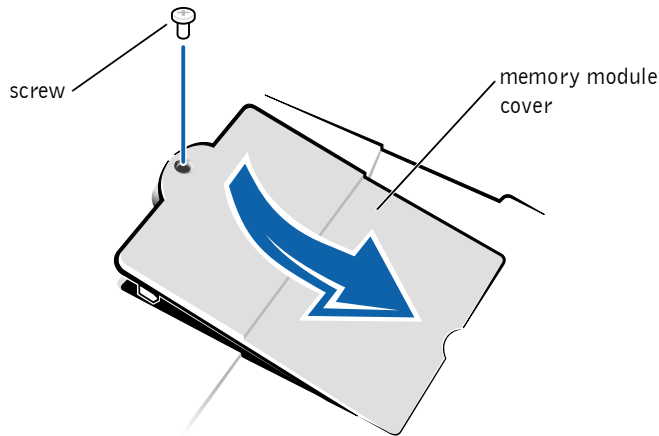

- 9** Insert the battery into the battery bay, or connect the AC adapter to your computer and an electrical outlet.

- 10** Turn on the computer.

As the computer boots, it will detect the additional memory and automatically update the system configuration information.

Installing a Mini PCI Card

The optional Mini PCI card may contain either a modem, a network adapter, or a combination of both. If you ordered a Mini PCI card at the same time that you ordered your computer, Dell has already installed the card for you.

- 1** Make sure that the work surface is flat and clean to prevent scratching the computer cover.
- 2** Save and close any open files, exit any open programs, and shut down the computer (see page 18).

- 3 Disconnect the computer from the electrical outlet.
- 4 Wait 10 to 20 seconds and then disconnect any attached devices.
- 5 Remove any installed PC Cards, batteries, and devices.
- 6 To ground yourself, periodically touch an unpainted metal surface on the back of the computer while you work.
- 7 Handle components and cards by their edges, and avoid touching pins and contacts.
- 8 Turn the computer over, and remove the screw from the Mini PCI card cover.
- 9 Place your finger under the cover at the indentation and lift and slide the cover open.

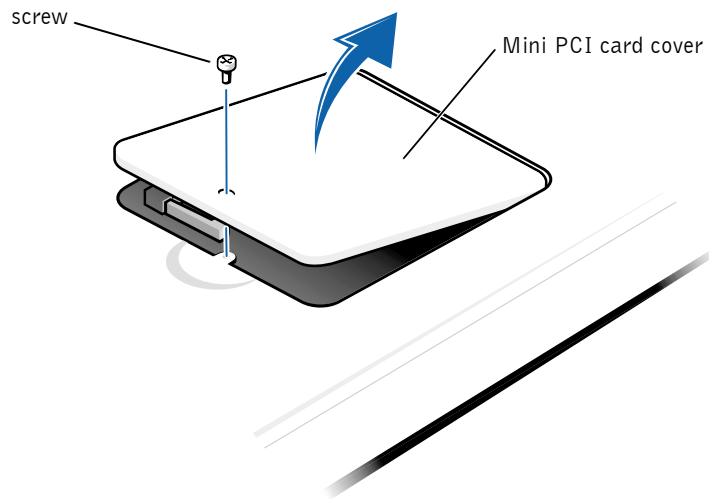

- 10 If a Mini PCI card is not already installed, go to step 11. If you are replacing a Mini PCI card, remove the existing card:
 - a To release the Mini PCI card, spread the metal securing tabs until the card pops up slightly.
 - b Disconnect the Mini PCI card from the wiring harness or internal antenna, if present.
 - c Lift the Mini PCI card out of its connector and disconnect any attached cables.

- 11 Align the Mini PCI card with the socket at a 45-degree angle, and press the Mini PCI card into the socket.
 - 12 Depending on the type of Mini PCI card you are installing, connect the wiring harness to the Mini PCI card, or connect the mini-coax cable from the Mini PCI card to the internal antenna.
- NOTICE:** The connectors are keyed for correct insertion; do not force the connections.

Mini PCI card connector

Mini PCI card

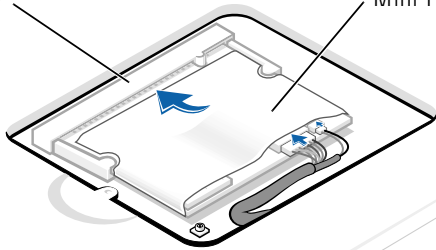

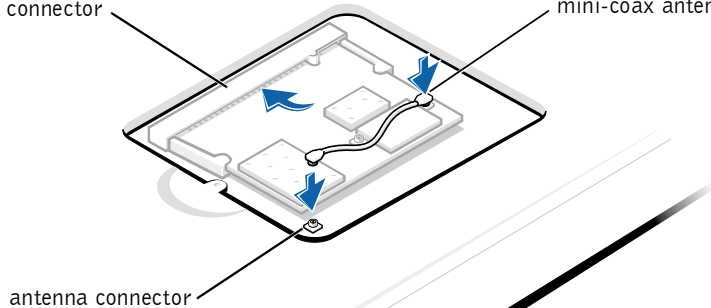

Mini PCI card connector

mini-coax antenna





antenna connector

 **HINT:** Dell does not guarantee compatibility or provide support for hard drives from sources other than Dell.

 **HINT:** You need the *Operating System* CD to install the Windows operating system. You also need the *Drivers and Utilities* CD to install the drivers and utilities on the new hard drive.

13 Lower the Mini PCI card toward the inner tabs to approximately a 20-degree angle, and connect the interface cable(s).

 **NOTICE:** If a wireless network adapter contains two mini-coax antenna connectors, connect the mini-coax cable to the outermost antenna.

 **NOTICE:** A modem-only Mini PCI card has one connector. Place the unused system board network adapter cable and connector under the Mini PCI card.

14 Continue lowering the Mini PCI card until it snaps into the inner tabs of the socket.

15 Replace the Mini PCI card cover.

Replacing a Hard Drive

 **NOTICE:** Hard drives are extremely fragile and must be handled carefully. Even a slight bump can damage the drive.

 **CAUTION:** If you remove the hard drive from the computer when the drive is hot, *do not touch* the metal housing of the hard drive.

 **NOTICE:** To prevent data loss, turn off your computer (see page 18) before removing or installing a hard drive. Do not remove the hard drive while the computer is in standby mode or hibernate mode, or if the power light is lit.

- 1** Save and close any open files, exit any open programs, and shut down the computer (see page 18).
- 2** Remove all installed batteries, and disconnect the AC adapter cable and any external devices from the computer.
- 3** Turn the computer over, and remove the hard drive screw.

bottom of computer

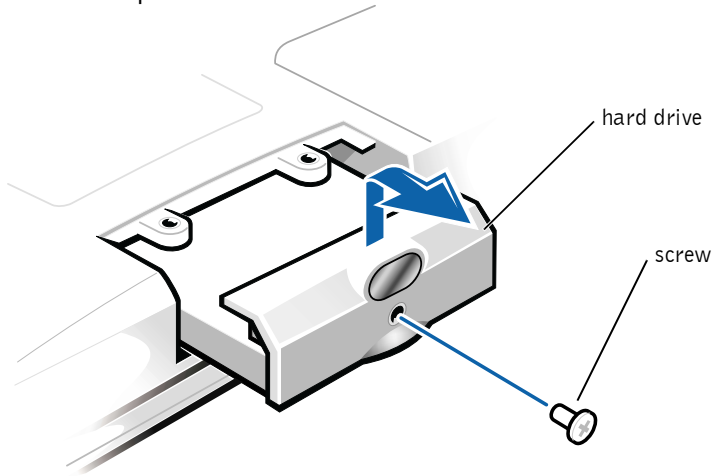

➔ **NOTICE:** When the hard drive is not in the computer, protect the drive from exposure to static electricity by storing it in protective antistatic packaging.

- 4 Lift up the hard drive cover until you hear a click.
- 5 Slide the hard drive out of the computer.
- 6 Remove the new drive from its packaging.

Save the original packaging to use when storing or shipping the hard drive.

➔ **NOTICE:** Do not force the drive into the computer. If you experience some resistance, use firm and even pressure to slide the drive into place.

- 7 Slide the new drive into the computer:
 - a Lift up the hard drive cover until you hear a click.
 - b Push the hard drive until it is fully seated in the bay.
 - c Press the hard drive cover down.
- 8 Replace and tighten the screw you removed in step 3.
- 9 Install the Dell-provided operating system (see page 45).
- 10 Install the Dell-provided drivers and utilities (see page 44).

Returning a Hard Drive to Dell

Return your old hard drive to Dell in its original foam packaging. Otherwise, the hard drive may be damaged in transit.

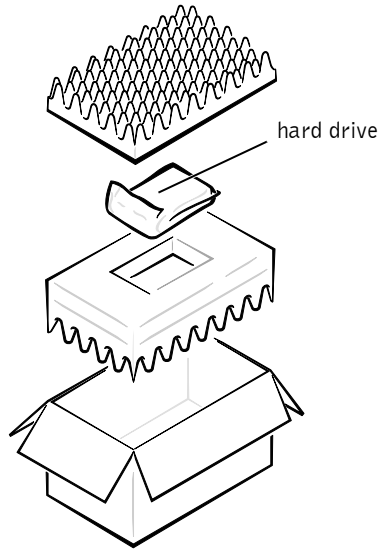

SECTION 4

Appendix

Specifications
Standard Settings
Contacting Dell
Regulatory Information
Limited Warranties and Return Policy

Specifications

Microprocessor

Microprocessor type	Intel [®] Mobile Pentium [®] III processor-M
L1 cache	32 KB (internal)
L2 cache	512 KB
Math coprocessor	internal to microprocessor

System Information

System chip set	Intel 815EP
Data bus width	64 bits
DRAM bus width	64 bits
Microprocessor address bus width	32 bits
Flash EPROM	4 Mb
Graphics bus width	32-bit AGP 4X cable bus

PC Card

CardBus controller	Texas Instruments PCI 4450/4451 CardBus controller
PC Card connectors	two (supports two Type I or Type II cards or one Type III card)
Cards supported	3.3 V and 5 V
PC Card connector size	68 pins
Data width (maximum)	PCMCIA 16 bits CardBus 32 bits

Memory

Architecture	SDRAM
Memory module connector	two user-accessible SODIMM sockets
Memory module capacities	64-, 128-, and 256-MB 3.3-V SDRAM SODIMMS
Standard memory	64 MB (non-ECC)
Maximum memory	512 MB (non-ECC)
Memory clock speed	133 MHz
Memory access time	CL2 or CL3 (NOTE: CL2 and CL3 indicate a CAS latency of two and three clocks, respectively.)

Ports and Connectors

Serial	9-pin connector; 16550C-compatible, 16-byte buffer connector
Parallel	unidirectional (standard AT), bidirectional, or ECP connector
Video	VGA connector
Audio	stereo (line-in) mini connector; microphone mini connector; headphone/speakers (line-out) mini connector
PS/2 keyboard/mouse	6-pin mini-DIN connector
USB	two USB-compliant connectors
Infrared	sensor compatible with both IrDA Standard 1.1 (Fast IR) and IrDA Standard 1.0 (Slow IR)
Docking	200-pin connector for Dell advanced port replicator
S-video TV-out	7-pin mini-DIN connector for S-video, composite video, and S/PDIF (TV/digital audio adapter cable supports composite video and S/PDIF)

Ports and Connectors *(continued)*

Modem/network adapter	optional factory-configurable RJ-11/RJ-45 combination port for Mini PCI card modem/network adapter
IEEE 1394	4-pin serial connector

Video

Video type	128-bit hardware-accelerated video support
Data bus	4X AGP
Video controller	NVIDIA GeForce2 Go™
Video memory	8 MB, 16 MB, and 32 MB (maximum)
LCD interface	LVDS
TV support	NTSC or PAL in S-video and composite modes

Audio

Audio controller	ESS Technology Maestro-3i
Stereo conversion	16 bit (analog-to-digital and digital-to-analog)
Interfaces:	
Internal	PCI bus/AC 97
External	stereo (line-in), microphone, headphones/speaker (line-out)

Display

Type	128-bit hardware-accelerated video support
Response time (typical)	50 ms
Operating angle	0° (closed) to 180°
Dot pitch	0.20 mm

Display *(continued)*

Panel (typical)	1.3 W
Backlight	3.4 W using battery; 4.9 W using AC adapter
Controls	brightness can be controlled through key combinations

Keyboard

Number of keys	87 (U.S., Canada, and locations that use traditional Chinese); 88 (Europe); 90 (Japan)
Key travel	2.7 ± 0.3 to 0.4 mm (0.11 ± 0.016 inch)
Key spacing	19.05 ± 0.3 mm (0.75 inch ± 0.012 inch)
Layout	QWERTY/AZERTY/Kanji

Touch Pad

Interface	PS/2 compatible
X/Y position resolution (graphics table mode)	240 cpi
Size:	
Thickness	2.00 mm (0.08 inch) at highest component
Width	64.88 mm (2.55 inch)
Height	48.88-mm (1.92-inch) rectangle with 0.5-mm (0.02-inch) tabs
Weight	6.5 g (0.23 ounce) ± 0.5 g (0.001 ounce)
Power:	
Supply voltage	5 V ± 0.5 VDC
Supply current	25 mA (maximum operating current) for track stick and touch pad combined
ESD	in accordance with IEC-801-2

Track Stick

Interface	PS/2 compatible
X/Y position resolution (graphics table mode)	250 count/sec @ 100 gf
Size	protrudes 0.5 mm higher than surrounding key caps
Power:	
Supply voltage	5 V \pm 0.5 VDC
Supply current	25 mA (maximum operating current) for track stick and touch pad combined
ESD	in accordance with IEC-801-2

Modem

Data/fax modem	optional 56K, V.90 Mini PCI card modem
Data/fax network adapter	optional 10/100 LAN + 56K, V.90 Mini PCI card modem

Battery

Type	8-cell lithium ion (dual battery support is available via the media bay)
Dimensions:	
Depth	88.5 mm (3.48 inches)
Height	21.5 mm (0.83 inch)
Width	139.0 mm (5.47 inches)
Weight	8 cell; 0.39 kg (0.87 lb)
Voltage	14.8 VDC
Charge time (approximate):	
Computer on	2.5 hours
Computer off	1 hour
Battery life	approximately 3 hours minimum with 8-cell standard battery

Battery *(continued)*

Life span (approximate)	400 discharge/charge cycles
Temperature range:	
Operating	0° to 45°C (32° to 113°F)
Storage	-20° to 60°C (-4° to 140°F)

AC Adapter

Input voltage	90 to 135 VAC and 164 to 264 VAC
Input current (maximum)	1.5 A
Input frequency	40 to 63 Hz
Output current	4.5 A (maximum 4-second pulse); 3.5 A (continuous)
Rated output voltage	20 VDC
Dimensions:	
Height	27.94 mm (1.1 inches)
Width	58.42 mm (2.3 inches)
Depth	133.85 mm (5.25 inches)
Weight (with cables)	0.4 kg (0.9 lb)
Temperature range:	
Operating	0° to 40°C (32° to 104°F)
Storage	-40° to 65°C (-40° to 149°F)

Environmental

Temperature range:	
Operating	0° to 35°C (32° to 95°F)
Storage	-40° to 65°C (-40° to 149°F)
Relative humidity (maximum):	
Operating	10% to 90% (noncondensing)
Storage	5% to 95% (noncondensing)

Environmental *(continued)*

Maximum vibration:

Operating	0.9 GRMS using a random-vibration spectrum that simulates user environment
Storage	1.3 GRMS using a random-vibration spectrum that simulates air/truck shipment

Maximum shock:

Operating	1.524 cm/sec (60 inches/sec) (equal to a half-sine pulse width of 2 ms)
Storage	2.03 m/sec (80 inches/sec) (less than or equal to a pulse width of 2 ms)

Altitude (maximum):

Operating	-15.2 to 3048 m (-50 to 10,000 ft)
Storage	-15.2 to 10,668 m (-50 to 35,000 ft)

Fixed Optical Drives

Supported drives	12.5-mm drives; CD, CD-RW, and DVD
------------------	------------------------------------

Standard Settings

The system setup program contains the standard settings for your computer.

 **NOTICE:** Unless you are an expert computer user, don't change the settings for this program. Certain changes might make your computer work incorrectly.

System Setup Pages

The system setup pages display the current setup information and settings for your computer. You can change settings that appear as white type on the screen.

- Page 1 displays system information.
- Page 2 displays boot configuration and dock configuration settings.
- Page 3 displays basic device configuration settings.
- Page 4 displays battery charge status.

 **HINT:** To see information about a specific item on the system setup page, highlight the item and refer to the **Help** area on the screen.

- Page 5 displays power management settings.
- Page 6 displays system security and hard drive password settings.

Viewing the System Setup Pages

- 1 Turn on (or restart) your computer.
- 2 When the Dell™ logo appears, press <F2> immediately.

If you wait too long and the Windows® logo appears, continue to wait until you see the Windows desktop. Then shut down your computer (see page 18) and try again.

Contacting Dell

When you need to contact Dell, use the telephone numbers, codes, and electronic addresses provided in the following table. If you need assistance in determining which codes to use, contact a local or an international operator.



HINT: Toll-free numbers are for use within the country for which they are listed.

Contact Numbers and Addresses

Country (City) International Access Code Country Code City Code	Department Name or Service Area, Website and E-mail Address	Area Codes, Local Numbers, and Toll Free Numbers
Australia (Sydney)	Home and Small Business	1-300-65-55-33
International Access Code: 0011	Government and Business	toll free: 1-800-633-559
Country Code: 61	Preferred Accounts Division (PAD)	toll free: 1-800-060-889
City Code: 2	Customer Care	toll free: 1-800-819-339
	Corporate Sales	toll free: 1-800-808-385
	Transaction Sales	toll free: 1-800-808-312
	Fax	toll free: 1-800-818-341

Country (City) International Access Code Country Code City Code	Department Name or Service Area, Website and E-mail Address	Area Codes, Local Numbers, and Toll Free Numbers
Austria (Vienna)	Home/Small Business Sales	01 795 67602
International Access Code: 900	Home/Small Business Fax	01 795 67605
Country Code: 43	Home/Small Business Customer Care	01 795 67603
City Code: 1	Preferred Accounts/Corporate Customer Care	0660 8056
	Home/Small Business Technical Support	01 795 67604
	Preferred Accounts/Corporate Technical Support	0660 8779
	Switchboard	01 491 04 0
	Website: http://support.euro.dell.com	
	E-mail: tech_support_central_europe@dell.com	
Belgium (Brussels)	Technical Support	02 481 92 88
International Access Code: 00	Customer Care	02 481 91 19
Country Code: 32	Home/Small Business Sales	toll free: 0800 16884
City Code: 2	Corporate Sales	02 481 91 00
	Fax	02 481 92 99
	Switchboard	02 481 91 00
	Website: http://support.euro.dell.com	
	E-mail: tech_be@dell.com	
Brazil	Customer Support, Technical Support	0800 90 3355
International Access Code: 0021	Sales	0800 90 3366
Country Code: 55	Website: http://www.dell.com/br	
City Code: 51		
Brunei	Customer Technical Support (Penang, Malaysia)	604 633 4966
Country Code: 673	Customer Service (Penang, Malaysia)	604 633 4949
	Transaction Sales (Penang, Malaysia)	604 633 4955

Country (City) International Access Code Country Code City Code	Department Name or Service Area, Website and E-mail Address	Area Codes, Local Numbers, and Toll Free Numbers
Canada (North York, Ontario) International Access Code: 011	Automated Order-Status System	toll free: 1-800-433-9014
	AutoTech (Automated technical support)	toll free: 1-800-247-9362
	Customer Care (From outside Toronto)	toll free: 1-800-387-5759
	Customer Care (From within Toronto)	416 758-2400
	Customer Technical Support	toll free: 1-800-847-4096
	Sales (Direct Sales—from outside Toronto)	toll free: 1-800-387-5752
	Sales (Direct Sales—from within Toronto)	416 758-2200
	Sales (Federal government, education, and medical)	toll free: 1-800-567-7542
	Sales (Major Accounts)	toll free: 1-800-387-5755
Chile (Santiago) Country Code: 56 City Code: 2	TechFax	toll free: 1-800-950-1329
	Sales, Customer Support, and Technical Support	toll free: 1230-020-4823
China (Xiamen) Country Code: 86 City Code: 592	Technical Support	toll free: 800 858 2437
	Customer Experience	toll free: 800 858 2060
	Home and Small Business	toll free: 800 858 2222
	Preferred Accounts Division	toll free: 800 858 2062
	Large Corporate Accounts	toll free: 800 858 2999
Czech Republic (Prague) International Access Code: 00 Country Code: 420 City Code: 2	Technical Support	02 22 83 27 27
	Customer Care	02 22 83 27 11
	Fax	02 22 83 27 14
	TechFax	02 22 83 27 28
	Switchboard	02 22 83 27 11
	Website: http://support.euro.dell.com E-mail: czech_dell@dell.com	

Country (City) International Access Code Country Code City Code	Department Name or Service Area, Website and E-mail Address	Area Codes, Local Numbers, and Toll Free Numbers
Denmark (Horsholm)	Technical Support	45170182
International Access Code: 00	Relational Customer Care	45170184
Country Code: 45	Home/Small Business Customer Care	32875505
	Switchboard	45170100
	Fax Technical Support (Upplands Vasby, Sweden)	46 0 859005594
	Fax Switchboard	45170117
	Website: http://support.euro.dell.com	
	E-mail: den_support@dell.com	
	E-mail Support for Servers: Nordic_server_support@dell.com	
Finland (Helsinki)	Technical Support	09 253 313 60
International Access Code: 990	Technical Support Fax	09 253 313 81
Country Code: 358	Relational Customer Care	09 253 313 38
City Code: 9	Home/Small Business Customer Care	09 693 791 94
	Fax	09 253 313 99
	Switchboard	09 253 313 00
	Website: http://support.euro.dell.com	
	E-mail: fin_support@dell.com	

Country (City) International Access Code Country Code City Code	Department Name or Service Area, Website and E-mail Address	Area Codes, Local Numbers, and Toll Free Numbers
France (Paris/Montpellier) International Access Code: 00 Country Code: 33 City Code: (1) (4)	Home and Small Business	
	Technical Support	0825 387 270
	Customer Care	0825 823 833
	Switchboard	0825 004 700
	Switchboard (Alternative)	04 99 75 40 00
	Sales	0825 004 700
	Fax	0825 004 701
	Website: http://support.euro.dell.com	
	E-mail: web_fr_tech@dell.com	
	Corporate	
Technical Support	0825 004 719	
Customer Care	0825 338 339	
Switchboard	01 55 94 71 00	
Sales	01 55 94 71 00	
Fax	01 55 94 71 01	
Website: http://support.euro.dell.com		
E-mail: web_fr_tech@dell.com		
Germany (Langen) International Access Code: 00 Country Code: 49 City Code: 6103	Technical Support	06103 766-7200
	Home/Small Business Customer Care	0180-5-224400
	Global Segment Customer Care	06103 766-9570
	Preferred Accounts Customer Care	06103 766-9420
	Large Accounts Customer Care	06103 766-9560
	Public Accounts Customer Care	06103 766-9555
	Switchboard	06103 766-7000
	Website: http://support.euro.dell.com	
	E-mail: tech_support_central_europe@dell.com	

Country (City) International Access Code Country Code City Code	Department Name or Service Area, Website and E-mail Address	Area Codes, Local Numbers, and Toll Free Numbers
Hong Kong	Technical Support	toll free: 800 96 4107
International Access Code: 001	Customer Service (Penang, Malaysia)	604 633 4949
Country Code: 852	Transaction Sales	toll free: 800 96 4109
	Corporate Sales	toll free: 800 96 4108
Ireland (Cherrywood)	Technical Support	0870 908 0800
International Access Code: 16	Home User Customer Care	01 204 4095
Country Code: 353	Small Business Customer Care	01 204 4026
City Code: 1	Corporate Customer Care	01 204 4003
	Sales	01 286 0500
	SalesFax	01 204 0144
	Fax	0870 907 5590
	Switchboard	01 286 0500
	Website: http://support.euro.dell.com	
	E-mail: dell_direct_support@dell.com	
Italy (Milan)	Home and Small Business	
International Access Code: 00	Technical Support	02 577 826 90
Country Code: 39	Customer Care	02 696 821 14
City Code: 02	Fax	02 696 821 13
	Switchboard	02 696 821 12
	Website: http://support.euro.dell.com	
	E-mail: web_it_tech@dell.com	
	Corporate	
	Technical Support	02 577 826 90
	Customer Care	02 577 825 55
	Fax	02 575 035 30
	Switchboard	02 577 821
	Website: http://support.euro.dell.com	
	E-mail: web_it_tech@dell.com	

Country (City) International Access Code Country Code City Code	Department Name or Service Area, Website and E-mail Address	Area Codes, Local Numbers, and Toll Free Numbers
Japan (Kawasaki) International Access Code: 001 Country Code: 81 City Code: 44	Technical Support (Server)	toll free: 0120-1984-35
	Technical Support (Dimension™ and Inspiron™)	toll free: 0120-1982-26
	Technical Support Outside of Japan (Dimension and Inspiron)	81-44-520-1435
	Technical Support (Dell Precision™, OptiPlex™ and Latitude™)	toll free: 0120-1984-33
	Technical Support Outside of Japan (Dell Precision, OptiPlex, and Latitude)	81-44-556-3894
	24-Hour Automated Order Service	044 556-3801
	Customer Care	044 556-4240
	Home and Small Business Group Sales	044 556-3344
	Business Sales Division (up to 400 employees)	044 556 3344
	Preferred Accounts Division Sales (over 400 employees)	044 556-3433
	Large Corporate Accounts Sales (over 3500 employees)	044 556-3430
	Government, Education, and Medical Sales	044 556 1469
	Dell Global Japan	044 556 3469
	Individual User	044 556 3344
Faxbox Service	044 556-3490	
Switchboard	044 556-4300	
Website: http://support.jp.dell.com		
Korea (Seoul) International Access Code: 001 Country Code: 82 City Code: 2	Technical Support	toll free: 080-200-3800
	Sales	toll free: 080-200-3600
	Customer Service (Seoul, Korea)	toll free: 080-200-3800
	Customer Service (Penang, Malaysia)	604 633 4949
	Fax	2194-6202
Switchboard	2194-6000	

Country (City) International Access Code Country Code City Code	Department Name or Service Area, Website and E-mail Address	Area Codes, Local Numbers, and Toll Free Numbers
Latin America	Customer Technical Support (Austin, Texas, U.S.A.)	512 728-4093
	Customer Service (Austin, Texas, U.S.A.)	512 728-3619
	Fax (Technical Support and Customer Service)(Austin, Texas, U.S.A.)	512 728-3883
	Sales (Austin, Texas, U.S.A.)	512 728-4397
	SalesFax (Austin, Texas, U.S.A.)	512 728-4600 or 512 728-3772
Luxembourg International Access Code: 00 Country Code: 352	Technical Support (Brussels, Belgium)	02 481 92 88
	Home/Small Business Sales (Brussels, Belgium)	toll free: 080016884
	Corporate Sales (Brussels, Belgium)	02 481 91 00
	Customer Care (Brussels, Belgium)	02 481 91 19
	Fax (Brussels, Belgium)	02 481 92 99
	Switchboard (Brussels, Belgium)	02 481 91 00
	Website: http://support.euro.dell.com E-mail: tech_be@dell.com	
Macau Country Code: 853	Technical Support	toll free: 0800 582
	Customer Service (Penang, Malaysia)	604 633 4949
	Transaction Sales	toll free: 0800 581
Malaysia (Penang) International Access Code: 00 Country Code: 60 City Code: 4	Technical Support	toll free: 1 800 888 298
	Customer Service	04 633 4949
	Transaction Sales	toll free: 1 800 888 202
	Corporate Sales	toll free: 1 800 888 213

Country (City) International Access Code Country Code City Code	Department Name or Service Area, Website and E-mail Address	Area Codes, Local Numbers, and Toll Free Numbers
Mexico International Access Code: 95 Country Code: 52 City Code: 5	Automated Order-Status System (Austin, Texas, U.S.A.)	512 728-0685
	AutoTech (Automated technical support) (Austin, Texas, U.S.A.)	512 728-0686
	Customer Technical Support	525 228-7870
	Sales	525 228-7811
		or toll free: 91-800-900-37
		or toll free: 91-800-904-49
	Customer Service Main	525 228-7878 525 228-7800
Netherlands (Amsterdam) International Access Code: 00 Country Code: 31 City Code: 20	Technical Support	020 581 8838
	Customer Care	020 581 8740
	Home/Small Business Sales	toll free: 0800-0663
	Home/Small Business Sales Fax	020 682 7171
	Corporate Sales	020 581 8818
	Corporate Sales Fax	020 686 8003
	Fax	020 686 8003
	Switchboard Website: http://support.euro.dell.com E-mail: tech_nl@dell.com	020 581 8818
New Zealand International Access Code: 00 Country Code: 64	Home and Small Business	0800 446 255
	Government and Business	0800 444 617
	Sales	0800 441 567
	Fax	0800 441 566

Country (City) International Access Code Country Code City Code	Department Name or Service Area, Website and E-mail Address	Area Codes, Local Numbers, and Toll Free Numbers
Norway (Lysaker)	Technical Support	671 16882
International Access Code: 00	Relational Customer Care	671 17514
Country Code: 47	Home/Small Business Customer Care	23162298
	Switchboard	671 16800
	Fax Technical Support (Upplands Vasby, Sweden)	46 0 85 590 05 594
	Fax Switchboard	671 16865
	Website: http://support.euro.dell.com	
	E-mail: nor_support@dell.com	
	E-mail Support for Servers: Nordic_server_support@dell.com	
Poland (Warsaw)	Technical Support	22 57 95 700
International Access Code: 011	Customer Care	22 57 95 999
Country Code: 48	Sales	22 57 95 999
City Code: 22	Fax	22 57 95 998
	Switchboard	22 57 95 999
	Website: http://support.euro.dell.com	
	E-mail: pl_support@dell.com	
Portugal	Technical Support	35 800 834 077
International Access Code: 00	Customer Care	800 300 415 or 35 800 834 075
Country Code: 35	Sales	800 300 410 or 800 300 411 or 800 300 412 or 351 214 220 710
	Fax	35 121 424 01 12
	E-mail: es_support@dell.com	
Singapore (Singapore)	Technical Support	toll free: 800 6011 051
International Access Code: 005	Customer Service (Penang, Malaysia)	604 633 4949
Country Code: 65	Transaction Sales	toll free: 800 6011 054
	Corporate Sales	toll free: 800 6011 053

Country (City) International Access Code Country Code City Code	Department Name or Service Area, Website and E-mail Address	Area Codes, Local Numbers, and Toll Free Numbers
South Africa (Johannesburg)	Technical Support	011 709 7710
International Access Code: 09/091	Customer Care	011 709 7707
Country Code: 27	Sales	011 709 7700
City Code: 11	Fax	011 706 0495
	Switchboard	011 709 7700
	Website: http://support.euro.dell.com	
	E-mail: dell_za_support@dell.com	
Southeast Asian and Pacific Countries	Customer Technical Support, Customer Service, and Sales (Penang, Malaysia)	604 633 4810
Spain (Madrid)	Home and Small Business	
International Access Code: 00	Technical Support	902 100 130
Country Code: 34	Customer Care	902 118 540
City Code: 91	Sales	902 118 541
	Switchboard	902 118 541
	Fax	902 118 539
	Website: http://support.euro.dell.com	
	E-mail: web_esp_tech@dell.com	
	Corporate	
	Technical Support	902 100 130
	Customer Care	902 118 546
	Switchboard	91 722 92 00
	Fax	91 722 95 83
	Website: http://support.euro.dell.com	
	E-mail: web_esp_tech@dell.com	

Country (City) International Access Code Country Code City Code	Department Name or Service Area, Website and E-mail Address	Area Codes, Local Numbers, and Toll Free Numbers
Sweden (Upplands Vasby)	Technical Support	08 590 05 199
International Access Code: 00	Relational Customer Care	08 590 05 642
Country Code: 46	Home/Small Business Customer Care	08 587 70 527
City Code: 8	Fax Technical Support	08 590 05 594
	Sales	08 590 05 185
	Website: http://support.euro.dell.com	
	E-mail: swe_support@dell.com	
	E-mail Support for Latitude and Inspiron: Swe-nbk_kats@dell.com	
	E-mail Support for OptiPlex: Swe_kats@dell.com	
	E-mail Support for Servers: Nordic_server_support@dell.com	
Switzerland (Geneva)	Technical Support (Home and Small Business)	0844 811 411
International Access Code: 00	Technical Support (Corporate)	0844 822 844
Country Code: 41	Customer Care (Home and Small Business)	0848 802 202
City Code: 22	Customer Care (Corporate)	0848 821 721
	Fax	022 799 01 90
	Switchboard	022 799 01 01
	Website: http://support.euro.dell.com	
	E-mail: swisstech@dell.com	
Taiwan	Technical Support	toll free: 0080 60 1255
International Access Code: 002	Technical Support (Servers)	toll free: 0080 60 1256
Country Code: 886	Transaction Sales	toll free: 0080 651 228 or 0800 33 556
	Corporate Sales	toll free: 0080 651 227 or 0800 33 555
Thailand	Technical Support	toll free: 0880 060 07
International Access Code: 001	Customer Service (Penang, Malaysia)	604 633 4949
Country Code: 66	Sales	toll free: 0880 060 09

Country (City) International Access Code Country Code City Code	Department Name or Service Area, Website and E-mail Address	Area Codes, Local Numbers, and Toll Free Numbers
U.K. (Bracknell) International Access Code: 010 Country Code: 44 City Code: 1344	Technical Support (Corporate/Preferred Accounts/PAD [1000+ employees]) Technical Support (Direct/PAD and General) Global Accounts Customer Care Home and Small Business Customer Care Corporate Customer Care Preferred Accounts (500-5000 employees) Customer Care Central Government Customer Care Local Government Customer Care Home/Small Business Sales Corporate/Public Sector Sales Website: http://support.euro.dell.com E-mail: dell_direct_support@dell.com	0870 908 0500 0870 908 0800 01344 723186 0870 906 0010 0870 908 0500 01344 723196 01344 723193 01344 723194 0870 907 4000 01344 860456

Country (City) International Access Code Country Code City Code	Department Name or Service Area, Website and E-mail Address	Area Codes, Local Numbers, and Toll Free Numbers
U.S.A. (Austin, Texas)	Automated Order-Status System	toll free: 1-800-433-9014
International Access Code: 011	AutoTech (for portable and desktop computers)	toll free: 1-800-247-9362
Country Code: 1	Dell Home and Small Business Group (for portable and desktop computers):	
	Customer Technical Support (Return Material Authorization Numbers)	toll free: 1-800-624-9896
	Customer Technical Support (Home sales purchased via http://www.dell.com)	toll free: 1-877-576-3355
	Customer Service (Credit Return Authorization Numbers)	toll free: 1-800-624-9897
	National Accounts (systems purchased by established Dell national accounts [have your account number handy], medical institutions, or value-added resellers [VARs]):	
	Customer Service and Technical Support (Return Material Authorization Numbers)	toll free: 1-800-822-8965
	Public Americas International (systems purchased by governmental agencies [local, state, or federal] or educational institutions):	
	Customer Service and Technical Support (Return Material Authorization Numbers)	toll free: 1-800-234-1490
	Dell Sales	toll free: 1-800-289-3355 or toll free: 1-800-879-3355
	Spare Parts Sales	toll free: 1-800-357-3355
	DellWare™	toll free: 1-800-753-7201
	Desktop and Portable Fee-Based Technical Support	toll free: 1-800-433-9005
	Server Fee-Based Technical Support	toll free: 1-800-967-0765
	Sales (Catalogs)	toll free: 1-800-426-5150
	Fax	toll free: 1-800-727-8320
	TechFax	toll free: 1-800-950-1329
	Dell Services for the Deaf, Hard-of-Hearing, or Speech-Impaired	toll free: 1-877-DELLTY (1-877-335-5889)
	Switchboard	512 338-4400
	Dellnet Technical Support	toll free: 1-877-Dellnet (1-877-335-5638)

Returning Items for Warranty Repair or Credit

- 1 Call Dell to obtain an authorization number, and write it clearly and prominently on the outside of the box.
- 2 Include a copy of the invoice and a letter describing the reason for the return.
- 3 Include any accessories that belong with the item(s) being returned (power cables, CDs, guides, and so on) if the return is for credit.
- 4 Pack the equipment to be returned in the original (or equivalent) packing materials.

You are responsible for paying shipping expenses. You are also responsible for insuring any product returned, and you assume the risk of loss during shipment to Dell. Collect-on-delivery packages are not accepted.

Returns that are missing any of the preceding requirements will be refused at our receiving dock and returned to you.

Regulatory Information

General EMC Guidelines

- Shielded signal cables: Using shielded cables ensures that you maintain the appropriate EMC classification for the intended environment. For parallel printers, a cable is available from Dell Computer Corporation. If you prefer, you can order a cable from Dell Computer Corporation on the World Wide Web at <http://www.dell.com>.
- Protecting against electrostatic discharge: static electricity can harm electronic components inside your computer. To prevent static damage, discharge static electricity from your body before you touch any of your computer's electronic components, such as a memory module. You can do so by touching an unpainted metal surface on the computer's I/O panel.

- Electromagnetic Interference (EMI) is any signal or emission, radiated in free space or conducted along power or signal leads, that endangers the functioning of a radio navigation or other safety service or seriously degrades, obstructs, or repeatedly interrupts a licensed radio communications service. Your Dell computer is designed to comply with applicable regulations regarding EMI. Changes or modifications not expressly approved by Dell could void the user's authority to operate the equipment.

Additional regulatory information regarding your computer can be found in the *Tell Me How* help file. To open the file, click the **Start** button on the Windows® desktop, point to **Programs—> User's Guides**, and then click **Tell Me How**.

FCC Notices (U.S. Only)

Most Dell computers are classified by the Federal Communications Commission (FCC) as Class B digital devices. However, the inclusion of certain options can change the rating of some configurations to Class A. To determine which classification applies to your computer, examine all FCC registration labels located on the bottom or back panel of your computer, on card-mounting brackets, and on the cards themselves. If any one of the labels carries a Class A rating, your entire computer is considered to be a Class A digital device. If *all* labels carry an FCC Class B rating as distinguished by either an FCC ID number or the FCC logo, (**FC**), your computer is considered to be a Class B digital device.

Once you have determined your computer's FCC classification, read the appropriate FCC notice. Note that FCC regulations provide that changes or modifications not expressly approved by Dell could void your authority to operate this equipment.

This device complies with Part 15 of the FCC Rules. Operation is subject to the following two conditions:

- This device may not cause harmful interference.
- This device must accept any interference received, including interference that may cause undesired operation.

Class A

This equipment has been tested and found to comply with the limits for a Class A digital device pursuant to Part 15 of the FCC Rules. These limits are designed to provide reasonable protection against harmful interference when the equipment is operated in a commercial environment. This equipment generates, uses, and can radiate radio frequency energy and, if not installed and used in accordance with the manufacturer's instruction manual, may cause harmful interference with radio communications. Operation of this equipment in a residential area is likely to cause harmful interference, in which case you will be required to correct the interference at your own expense.

Class B

This equipment has been tested and found to comply with the limits for a Class B digital device pursuant to Part 15 of the FCC Rules. These limits are designed to provide reasonable protection against harmful interference in a residential installation. This equipment generates, uses, and can radiate radio frequency energy and, if not installed and used in accordance with the manufacturer's instruction manual, may cause interference with radio communications. However, there is no guarantee that interference will not occur in a particular installation. If this equipment does cause harmful interference to radio or television reception, which can be determined by turning the equipment off and on, you are encouraged to try to correct the interference by one or more of the following measures:

- Reorient or relocate the receiving antenna.
- Increase the separation between the equipment and the receiver.
- Connect the equipment into an outlet on a circuit different from that to which the receiver is connected.
- Consult the dealer or an experienced radio/television technician for help.

The following information is provided on the device or devices covered in this document in compliance with FCC regulations:

- Model number: PP01X
- Company name:
Dell Computer Corporation
One Dell Way
Round Rock, Texas 78682 USA

Modem Regulatory Information

This equipment complies with Part 68 of the FCC rules. On the bottom of your computer is a label that contains, among other information, the FCC registration number and ringer equivalence number (REN) for your equipment. If requested, you must provide this information to the telephone company.

The REN is used to determine the quantity of devices that may be connected to the telephone line. Excessive RENs on the telephone line may result in the devices not ringing in response to an incoming call. In most areas, the sum of all the RENs on your telephone line should be less than five to ensure proper service from the telephone company. To be certain of the number of devices that you may connect to a line, as determined by the total RENs, contact your local telephone company.

The registration jack Universal Service Order Code (USOC) used by this equipment is RJ-11C. An FCC compliant telephone cord and modular plug is provided with this equipment. This equipment is designed to be connected to the telephone network or premises wiring using a compatible modular jack that is Part 68 compliant.

This equipment cannot be used on public coin-phone service provided by the telephone company. Connection to party line service is subject to state tariffs.

There are no user serviceable parts on the modem contained in your computer.

If your telephone equipment causes harm to the telephone network, the telephone company will notify you in advance that service may be temporarily discontinued. If advance notice is not practical, the telephone company will notify you as soon as possible. Also, you will be advised of your right to file a complaint with the FCC if you believe it is necessary.

The telephone company may make changes in its facilities, equipment, operations, or procedures that could affect the operation of this equipment. If this happens, the telephone company will provide advance notice in order for you to make necessary modifications to maintain uninterrupted service.

If you experience trouble with this telephone equipment, see “Contacting Dell” on page 73 to find the appropriate contact information for obtaining customer assistance. If the equipment is causing harm to the telephone network, the telephone company may request that you disconnect the equipment until the problem is resolved.

Fax Branding

The Telephone Consumer Protection Act of 1991 makes it unlawful for any person to use a computer or other electronic device, including fax machines, to send any message unless such message clearly contains in a margin at the top or bottom of each transmitted page or on the first page of the transmission, the date and time it is sent, identification of the business, other entity, or individual sending the message, and the telephone number of the sending machine or such business, other entity, or individual. The telephone number provided may not be a 900 number or any other number for which charges exceed local or long-distance transmission charges.

Battery Disposal

Your computer uses a lithium-ion battery and a nickel-metal hydride (NiMH) coin-cell battery. For instructions about replacing the lithium-ion battery in your computer, see the *Tell Me How* help file. To open the file, click the **Start** button on the Windows desktop, point to **Programs**—> **User’s Guides**, and then click **Tell Me How**.



The coin-cell battery is a long-life battery, and it is very possible that you will never need to replace it. However, should you need to replace it, the procedure must be performed by an authorized service technician.

Do not dispose of the battery along with household waste. Contact your local waste disposal agency for the address of the nearest battery deposit site.

NOM Information (Mexico Only)

The following information is provided on the device(s) described in this document in compliance with the requirements of the official Mexican standards (NOM):

Exporter:	Dell Computer Corporation One Dell Way Round Rock, TX 78682
Importer:	Dell Computer de México, S.A. de C.V. Paseo de la Reforma 2620 - 11° Piso Col. Lomas Altas 11950 México, D.F.
Ship to:	Dell Computer de México, S.A. de C.V. al Cuidado de Kuehne & Nagel de México S. de R.I. Avenida Soles No. 55 Col. Peñon de los Baños 15520 México, D.F.
Supply voltage:	100–240 VAC
Frequency:	50–60 Hz
Current consumption:	1.5 A
System input voltage:	20 VDC
System input current	3.5 A

Información para NOM (únicamente para México)

La información siguiente se proporciona en el dispositivo o en los dispositivos descritos en este documento, en cumplimiento con los requisitos de la Norma Oficial Mexicana (NOM):

Exportador:	Dell Computer Corporation One Dell Way Round Rock, TX 78682
Importador:	Dell Computer de México, S.A. de C.V. Paseo de la Reforma 2620 - 11° Piso Col. Lomas Altas 11950 México, D.F
Embarcar a:	Dell Computer de México, S.A. de C.V. al Cuidado de Kuehne & Nagel de México S. de R.I. Avenida Soles No. 55 Col. Peñon de los Baños 15520 México, D.F
Tensión alimentación:	100–240 VAC
Frecuencia:	50–60 Hz
Consumo de corriente:	1.5 A
Voltaje de entrada del sistema:	20 VDC
Corriente de entrada del sistema	3.5 A

Limited Warranties and Return Policy

Dell-branded hardware products purchased in the U.S. or Canada come with either a one-year limited warranty, a two-year limited warranty, or a three-year limited warranty. To determine which warranty you purchased, see the Dell invoice that accompanied your computer. The following sections describe these limited warranties.

One-Year Limited Warranty (U.S. Only)

Dell Computer Corporation (“Dell”) manufactures its hardware products from parts and components that are new or equivalent to new in accordance with industry-standard practices. Dell warrants that the hardware products it manufactures will be free from defects in materials and workmanship. The limited warranty term is one year beginning on the date of invoice, as further described in the following text.

Damage due to shipping the products to you is covered under this limited warranty. Otherwise, this limited warranty does not cover damage due to external causes, including accident, abuse, misuse, problems with electrical power, servicing not authorized by Dell, usage not in accordance with product instructions, failure to perform required preventive maintenance, and problems caused by use of parts and components not supplied by Dell.

This limited warranty does not cover any items that are in one or more of the following categories: software; external devices (except as specifically noted); accessories or parts added to a Dell system after the system is shipped from Dell; accessories or parts added to a Dell system through Dell’s system integration department; accessories or parts that are not installed in the Dell factory; or DellWare™ products. Monitors, keyboards, and mice that are Dell-branded or that are included on Dell’s standard price list are covered under this limited warranty; all other monitors, keyboards, and mice (including those sold through the DellWare program) are not covered.

Dell will repair or replace products covered under this limited warranty that are returned to Dell’s facility. To request warranty service, you must contact Dell’s Customer Technical Support within the limited warranty period. See “Contacting Dell” on page 73 to find the appropriate contact information for obtaining customer assistance. If warranty service is required, Dell will issue a Return Material Authorization Number. You must ship the products back to Dell in their original or equivalent packaging, prepay shipping charges, and insure the shipment or accept the risk of loss or damage during shipment. Dell will ship the repaired or replacement products to you (freight prepaid) if you use an address in the continental U.S., where applicable. Shipments to other locations will be made freight collect.

 **NOTE:** Before you ship the product(s) to Dell, back up the data on the hard drive(s) and any other storage device(s) in the product(s). Remove any removable media, such as floppy disks, CDs, or PC Cards. Dell does not accept liability for lost data or software.

Dell owns all parts removed from repaired products. Dell uses new and reconditioned parts made by various manufacturers in performing warranty repairs and building replacement products. If Dell repairs or replaces a product, its warranty term is not extended.

THIS LIMITED WARRANTY GIVES YOU SPECIFIC LEGAL RIGHTS, AND YOU MAY ALSO HAVE OTHER RIGHTS, WHICH VARY FROM STATE TO STATE (OR JURISDICTION TO JURISDICTION). DELL'S RESPONSIBILITY FOR MALFUNCTIONS AND DEFECTS IN HARDWARE IS LIMITED TO REPAIR AND REPLACEMENT AS SET FORTH IN THIS LIMITED WARRANTY STATEMENT. ALL EXPRESS AND IMPLIED WARRANTIES FOR THE PRODUCT, INCLUDING BUT NOT LIMITED TO ANY IMPLIED WARRANTIES OF AND CONDITIONS OF MERCHANTABILITY AND FITNESS FOR A PARTICULAR PURPOSE, ARE LIMITED IN DURATION TO THE WARRANTY PERIOD SET FORTH ABOVE AND NO WARRANTIES, WHETHER EXPRESS OR IMPLIED, WILL APPLY AFTER SUCH PERIOD.

SOME STATES (OR JURISDICTIONS) DO NOT ALLOW LIMITATIONS ON HOW LONG AN IMPLIED WARRANTY LASTS, SO THE PRECEDING LIMITATION MAY NOT APPLY TO YOU.

DELL DOES NOT ACCEPT LIABILITY BEYOND THE REMEDIES SET FORTH IN THIS LIMITED WARRANTY STATEMENT OR LIABILITY FOR INCIDENTAL OR CONSEQUENTIAL DAMAGES, INCLUDING WITHOUT LIMITATION ANY LIABILITY FOR PRODUCTS NOT BEING AVAILABLE FOR USE OR FOR LOST DATA OR SOFTWARE.

SOME STATES (OR JURISDICTIONS) DO NOT ALLOW THE EXCLUSION OR LIMITATION OF INCIDENTAL OR CONSEQUENTIAL DAMAGES, SO THE PRECEDING EXCLUSION OR LIMITATION MAY NOT APPLY TO YOU.

These provisions apply to Dell's one-year limited warranty only. For provisions of any service contract covering your system, refer to your invoice or the separate service contract that you will receive.

If Dell elects to exchange a product or portion of a product, the exchange will be made in accordance with Dell's Exchange Policy in effect on the date of the exchange. In any instance in which Dell issues a Return Material Authorization Number, Dell must receive the product(s) for repair prior to the expiration of the warranty period in order for the repair(s) to be covered by the limited warranty.

Two-Year Limited Warranty (U.S. Only)

Dell Computer Corporation ("Dell") manufactures its hardware products from parts and components that are new or equivalent to new in accordance with industry-standard practices. Dell warrants that the hardware products it manufactures will be free from defects in materials and workmanship. The limited warranty term is two years beginning on the date of invoice, as further described in the following section.

Damage due to shipping the products to you is covered under this warranty. Otherwise, this limited warranty does not cover damage due to external causes, including accident, abuse, misuse, problems with electrical power, servicing not authorized by Dell, usage not in accordance with product instructions, failure to perform required preventive maintenance, and problems caused by use of parts and components not supplied by Dell.

This limited warranty does not cover any items that are in one or more of the following categories: software; external devices (except as specifically noted); accessories or parts added to a Dell system after the system is shipped from Dell; accessories or parts added to a Dell system through Dell's system integration department; accessories or parts that are not installed in the Dell factory; or DellWare products. Monitors, keyboards, and mice that are Dell-branded or that are included on Dell's standard price list are covered under this warranty; all other monitors, keyboards, and mice (including those sold through the DellWare program) are not covered. Batteries for portable computers are covered only during the initial one-year period of this limited warranty.

Limited Warranty Coverage During Year One

During the one-year period beginning on the invoice date, Dell will repair or replace products covered under this limited warranty that are returned to Dell's facility. To request warranty service, you must contact Dell's Customer Technical Support within the warranty period. See "Contacting Dell" on page 73 to find the appropriate contact information for obtaining customer assistance. If warranty service is required, Dell will issue a Return Material Authorization Number. You must ship the products back to Dell in their original or equivalent packaging, prepay shipping charges, and insure the shipment or accept the risk of loss or damage during shipment. Dell will ship the repaired or replacement products to you freight prepaid if you use an address in the continental U.S., where applicable. Shipments to other locations will be made freight collect.



NOTE: Before you ship the product(s) to Dell, back up the data on the hard drive(s) and any other storage device(s) in the product(s). Remove any removable media, such as floppy disks, CDs, or PC Cards. Dell does not accept liability for lost data or software.

Dell owns all parts removed from repaired products. Dell uses new and reconditioned parts made by various manufacturers in performing warranty repairs and building replacement products. If Dell repairs or replaces a product, its warranty term is not extended.

Limited Warranty Coverage During Year Two

During the second year of this limited warranty, Dell will provide, on an exchange basis and subject to Dell's Exchange Policy in effect on the date of the exchange, replacement parts for the Dell hardware product(s) covered under this limited warranty when a part requires replacement. You must report each instance of hardware failure to Dell's Customer Technical Support in advance to obtain Dell's concurrence that a part should be replaced and to have Dell ship the replacement part. Dell will ship parts (freight prepaid) if you use an address in the continental U.S., where applicable. Shipments to other locations, where applicable, will be made freight collect. Dell will include a prepaid shipping container with each replacement part for your use in returning the replaced part to Dell. Replacement parts are new or reconditioned. Dell may provide replacement parts made by various manufacturers when supplying parts to you. The warranty term for a replacement part is the remainder of the limited warranty term.

You will pay Dell for replacement parts if the replaced part is not returned to Dell. The process for returning replaced parts, and your obligation to pay for replacement parts if you do not return the replaced parts to Dell, will be in accordance with Dell's Exchange Policy in effect on the date of the exchange.

You accept full responsibility for your software and data. Dell is not required to advise or remind you of appropriate backup and other procedures.

General Provisions

THIS LIMITED WARRANTY GIVES YOU SPECIFIC LEGAL RIGHTS, AND YOU MAY ALSO HAVE OTHER RIGHTS, WHICH VARY FROM STATE TO STATE (OR JURISDICTION TO JURISDICTION). DELL'S RESPONSIBILITY FOR MALFUNCTIONS AND DEFECTS IN HARDWARE IS LIMITED TO REPAIR AND REPLACEMENT AS SET FORTH IN THIS LIMITED WARRANTY STATEMENT. ALL EXPRESS AND IMPLIED WARRANTIES FOR THE PRODUCT, INCLUDING BUT NOT LIMITED TO ANY IMPLIED WARRANTIES OF AND CONDITIONS OF MERCHANTABILITY AND FITNESS FOR A PARTICULAR PURPOSE, ARE LIMITED IN DURATION TO THE WARRANTY PERIOD SET FORTH ABOVE AND NO WARRANTIES, WHETHER EXPRESS OR IMPLIED, WILL APPLY AFTER SUCH PERIOD. SOME STATES (OR JURISDICTIONS) DO NOT ALLOW LIMITATIONS ON HOW LONG AN IMPLIED WARRANTY LASTS, SO THE PRECEDING LIMITATION MAY NOT APPLY TO YOU.

DELL DOES NOT ACCEPT LIABILITY BEYOND THE REMEDIES SET FORTH IN THIS LIMITED WARRANTY STATEMENT OR LIABILITY FOR INCIDENTAL OR CONSEQUENTIAL DAMAGES, INCLUDING WITHOUT LIMITATION ANY LIABILITY FOR PRODUCTS NOT BEING AVAILABLE FOR USE OR FOR LOST DATA OR SOFTWARE. SOME STATES (OR JURISDICTIONS) DO NOT ALLOW THE EXCLUSION OR LIMITATION OF INCIDENTAL OR CONSEQUENTIAL DAMAGES, SO THE PRECEDING EXCLUSION OR LIMITATION MAY NOT APPLY TO YOU.

These provisions apply to Dell's two-year limited warranty only. For provisions of any service contract covering your system, refer to your invoice or the separate service contract that you will receive.

If Dell elects to exchange a system or component, the exchange will be made in accordance with Dell's Exchange Policy in effect on the date of the exchange. In any instance in which Dell issues a Return Material Authorization Number, Dell must receive the product(s) for repair prior to the expiration of the warranty period in order for the repair(s) to be covered by the limited warranty.

Three-Year Limited Warranty (U.S. Only)

Dell Computer Corporation ("Dell") manufactures its hardware products from parts and components that are new or equivalent to new in accordance with industry-standard practices. Dell warrants that the hardware products it manufactures will be free from defects in materials and workmanship. The limited warranty term is three years beginning on the date of invoice, as described in the following text.

Damage due to shipping the products to you is covered under this limited warranty. Otherwise, this limited warranty does not cover damage due to external causes, including accident, abuse, misuse, problems with electrical power, servicing not authorized by Dell, usage not in accordance with product instructions, failure to perform required preventive maintenance, and problems caused by use of parts and components not supplied by Dell.

This limited warranty does not cover any items that are in one or more of the following categories: software; external devices (except as specifically noted); accessories or parts added to a Dell system after the system is shipped from Dell; accessories or parts added to a Dell system through Dell's system integration department; accessories or parts that are not installed in the Dell factory; or DellWare products. Monitors, keyboards, and mice that are Dell-branded or that are included on Dell's standard price list are covered under this limited warranty; all other monitors, keyboards, and mice (including those sold through the DellWare program) are not covered. Batteries for portable computers are covered only during the initial one-year period of this limited warranty.

Coverage During Year One

During the one-year period beginning on the invoice date, Dell will repair or replace products covered under this limited warranty that are returned to Dell's facility. To request warranty service, you must contact Dell's Customer Technical Support within the warranty period. See "Contacting Dell" on page 73 to find the appropriate contact information for obtaining customer assistance. If warranty service is required, Dell will issue a Return Material Authorization Number. You must ship the products back to Dell in their original or equivalent packaging, prepay shipping charges, and insure the shipment or accept the risk of loss or damage during shipment. Dell will ship the repaired or replacement products to you freight prepaid if you use an address in the continental U.S., where applicable. Shipments to other locations will be made freight collect.



NOTE: Before you ship the product(s) to Dell, back up the data on the hard drive(s) and any other storage device(s) in the product(s). Remove any removable media, such as floppy disks, CDs, or PC Cards. Dell does not accept liability for lost data or software.

Dell owns all parts removed from repaired products. Dell uses new and reconditioned parts made by various manufacturers in performing warranty repairs and building replacement products. If Dell repairs or replaces a product, its warranty term is not extended.

Coverage During Years Two and Three

During the second and third years of this limited warranty, Dell will provide, on an exchange basis and subject to Dell's Exchange Policy in effect on the date of the exchange, replacement parts for the Dell hardware product(s) covered under this limited warranty when a part requires replacement. You must report each instance of hardware failure to Dell's Customer Technical Support in advance to obtain Dell's concurrence that a part should be replaced and to have Dell ship the replacement part. Dell will ship parts (freight prepaid) if you use an address in the continental U.S., where applicable. Shipments to other locations will be made freight collect. Dell will include a prepaid shipping container with each replacement part for your use in returning the replaced part to Dell. Replacement parts are new or reconditioned. Dell may provide replacement parts made by various manufacturers when supplying parts to you. The warranty term for a replacement part is the remainder of the limited warranty term.

You will pay Dell for replacement parts if the replaced part is not returned to Dell. The process for returning replaced parts, and your obligation to pay for replacement parts if you do not return the replaced parts to Dell, will be in accordance with Dell's Exchange Policy in effect on the date of the exchange.

You accept full responsibility for your software and data. Dell is not required to advise or remind you of appropriate backup and other procedures.

General Provisions

THIS LIMITED WARRANTY GIVES YOU SPECIFIC LEGAL RIGHTS, AND YOU MAY ALSO HAVE OTHER RIGHTS, WHICH VARY FROM STATE TO STATE (OR JURISDICTION TO JURISDICTION). DELL'S RESPONSIBILITY FOR MALFUNCTIONS AND DEFECTS IN HARDWARE IS LIMITED TO REPAIR AND REPLACEMENT AS SET FORTH IN THIS LIMITED WARRANTY STATEMENT. ALL EXPRESS AND IMPLIED WARRANTIES FOR THE PRODUCT, INCLUDING BUT NOT LIMITED TO ANY IMPLIED WARRANTIES OF AND CONDITIONS OF MERCHANTABILITY AND FITNESS FOR A PARTICULAR PURPOSE, ARE LIMITED IN DURATION TO THE WARRANTY PERIOD SET FORTH ABOVE AND NO WARRANTIES, WHETHER EXPRESS OR IMPLIED, WILL APPLY AFTER SUCH PERIOD.

SOME STATES (OR JURISDICTIONS) DO NOT ALLOW LIMITATIONS ON HOW LONG AN IMPLIED WARRANTY LASTS, SO THE PRECEDING LIMITATION MAY NOT APPLY TO YOU.

DELL DOES NOT ACCEPT LIABILITY BEYOND THE REMEDIES SET FORTH IN THIS LIMITED WARRANTY STATEMENT OR LIABILITY FOR INCIDENTAL OR CONSEQUENTIAL DAMAGES, INCLUDING WITHOUT LIMITATION ANY LIABILITY FOR PRODUCTS NOT BEING AVAILABLE FOR USE OR FOR LOST DATA OR SOFTWARE.

SOME STATES (OR JURISDICTIONS) DO NOT ALLOW THE EXCLUSION OR LIMITATION OF INCIDENTAL OR CONSEQUENTIAL DAMAGES, SO THE PRECEDING EXCLUSION OR LIMITATION MAY NOT APPLY TO YOU.

These provisions apply to Dell's three-year limited warranty only. For provisions of any service contract covering your system, refer to your invoice or the separate service contract that you will receive.

If Dell elects to exchange a system or component, the exchange will be made in accordance with Dell's Exchange Policy in effect on the date of the exchange. In any instance in which Dell issues a Return Material Authorization Number, Dell must receive the product(s) for repair prior to the expiration of the warranty period in order for the repair(s) to be covered by the limited warranty.

One-Year Limited Warranty (Canada Only)

Dell Computer Corporation ("Dell") manufactures its hardware products from parts and components that are new or equivalent to new in accordance with industry-standard practices. Dell warrants that the hardware products it manufactures will be free from defects in materials and workmanship. The limited warranty term is one year beginning on the date of invoice, as further described in the following text.

Damage due to shipping the products to you is covered under this limited warranty. Otherwise, this limited warranty does not cover damage due to external causes, including accident, abuse, misuse, problems with electrical power, servicing not authorized by Dell, usage not in accordance with product instructions, failure to perform required preventive maintenance, and problems caused by use of parts and components not supplied by Dell.

This limited warranty does not cover any items that are in one or more of the following categories: software; external devices (except as specifically noted); accessories or parts added to a Dell system after the system is shipped from Dell; accessories or parts added to a Dell system through Dell's system integration department; accessories or parts that are not installed in the Dell factory; or DellWare products. Monitors, keyboards, and mice that are Dell-branded or that are included on Dell's standard price list are covered under this limited warranty; all other monitors, keyboards, and mice (including those sold through the DellWare program) are not covered.

Dell will repair or replace products covered under this limited warranty that are returned to Dell's facility. To request warranty service, you must contact Dell's Customer Technical Support within the warranty period. See "Contacting Dell" on page 73 to find the appropriate contact information for obtaining customer assistance. If warranty service is required, Dell will issue a Return Material Authorization Number. You must ship the products back to Dell in their original or equivalent packaging, prepay shipping charges, and insure the shipment or accept the risk of loss or damage during shipment. Dell will ship the repaired or replacement products to you (freight prepaid) if you use an address in Canada, where applicable. Shipments to other locations will be made freight collect.

 **NOTE:** Before you ship the product(s) to Dell, back up the data on the hard drive(s) and any other storage device(s) in the product(s). Remove any removable media, such as floppy disks, CDs, or PC Cards. Dell does not accept liability for lost data or software.

Dell owns all parts removed from repaired products. Dell uses new and reconditioned parts made by various manufacturers in performing warranty repairs and building replacement products. If Dell repairs or replaces a product, its warranty term is not extended.

DELL MAKES NO EXPRESS WARRANTIES OR CONDITIONS BEYOND THOSE STATED IN THIS LIMITED WARRANTY STATEMENT. DELL DISCLAIMS ALL OTHER WARRANTIES AND CONDITIONS, EXPRESS OR IMPLIED, INCLUDING WITHOUT LIMITATION IMPLIED WARRANTIES AND CONDITIONS OF MERCHANTABILITY AND FITNESS FOR A PARTICULAR PURPOSE. SOME STATES (OR JURISDICTIONS) DO NOT ALLOW LIMITATIONS ON IMPLIED WARRANTIES OR CONDITIONS, SO THIS LIMITATION MAY NOT APPLY TO YOU.

DELL'S RESPONSIBILITY FOR MALFUNCTIONS AND DEFECTS IN HARDWARE IS LIMITED TO REPAIR AND REPLACEMENT AS SET FORTH IN THIS LIMITED WARRANTY STATEMENT. THESE WARRANTIES GIVE YOU SPECIFIC LEGAL RIGHTS, AND YOU MAY ALSO HAVE OTHER RIGHTS, WHICH VARY FROM STATE TO STATE (OR JURISDICTION TO JURISDICTION).

DELL DOES NOT ACCEPT LIABILITY BEYOND THE REMEDIES SET FORTH IN THIS LIMITED WARRANTY STATEMENT OR LIABILITY FOR INCIDENTAL OR CONSEQUENTIAL DAMAGES, INCLUDING WITHOUT LIMITATION ANY LIABILITY FOR PRODUCTS NOT BEING AVAILABLE FOR USE OR FOR LOST DATA OR SOFTWARE.

SOME STATES (OR JURISDICTIONS) DO NOT ALLOW THE EXCLUSION OR LIMITATION OF INCIDENTAL OR CONSEQUENTIAL DAMAGES, SO THE PRECEDING EXCLUSION OR LIMITATION MAY NOT APPLY TO YOU.

These provisions apply to Dell's one-year limited warranty only. For provisions of any service contract covering your system, refer to your invoice or the separate service contract that you will receive.

If Dell elects to exchange a product or portion of a product, the exchange will be made in accordance with Dell's Exchange Policy in effect on the date of the exchange. In any instance in which Dell issues a Return Material Authorization Number, Dell must receive the product(s) for repair prior to the expiration of the warranty period in order for the repair(s) to be covered by the limited warranty.

Two-Year Limited Warranty (Canada Only)

Dell Computer Corporation ("Dell") manufactures its hardware products from parts and components that are new or equivalent to new in accordance with industry-standard practices. Dell warrants that the hardware products it manufactures will be free from defects in materials and workmanship. The warranty term is two years beginning on the date of invoice, as described in the following text.

Damage due to shipping the products to you is covered under this limited warranty. Otherwise, this limited warranty does not cover damage due to external causes, including accident, abuse, misuse, problems with electrical power, servicing not authorized by Dell, usage not in accordance with product instructions, failure to perform required preventive maintenance, and problems caused by use of parts and components not supplied by Dell.

This limited warranty does not cover any items that are in one or more of the following categories: software; external devices (except as specifically noted); accessories or parts added to a Dell system after the system is shipped from Dell; accessories or parts added to a Dell system through Dell's system integration department; accessories or parts that are not installed in the Dell factory; or DellWare products. Monitors, keyboards, and mice that are Dell-branded or that are included on Dell's standard price list are covered under this limited warranty; all other monitors, keyboards, and mice (including those sold through the DellWare program) are not covered. Batteries for portable computers are covered only during the initial one-year period of this limited warranty.

Coverage During Year One

During the one-year period beginning on the invoice date, Dell will repair or replace products covered under this limited warranty that are returned to Dell's facility. To request warranty service, you must contact Dell's Customer Technical Support within the warranty period. See "Contacting Dell" on page 73 to find the appropriate contact information for obtaining customer assistance. If warranty service is required, Dell will issue a Return Material Authorization Number. You must ship the products back to Dell in their original or equivalent packaging, prepay shipping charges, and insure the shipment or accept the risk of loss or damage during shipment. Dell will ship the repaired or replacement products to you freight prepaid if you use an address in Canada, where applicable. Shipments to other locations will be made freight collect.



NOTE: Before you ship the product(s) to Dell, back up the data on the hard drive(s) and any other storage device(s) in the product(s). Remove any removable media, such as floppy disks, CDs, or PC Cards. Dell does not accept liability for lost data or software.

Dell owns all parts removed from repaired products. Dell uses new and reconditioned parts made by various manufacturers in performing warranty repairs and building replacement products. If Dell repairs or replaces a product, its warranty term is not extended.

Coverage During Year Two

During the second year of this limited warranty, Dell will provide, on an exchange basis and subject to Dell's Exchange Policy in effect on the date of the exchange, replacement parts for the Dell hardware product(s) covered under this limited warranty when a part requires replacement. You must report each instance of hardware failure to Dell's Customer Technical Support in advance to obtain Dell's concurrence that a part should be replaced and to have Dell ship the replacement part. Dell will ship parts (freight prepaid) if you use an address in Canada, where applicable. Shipments to other locations will be made freight collect. Dell will include a prepaid shipping container with each replacement part for your use in returning the replaced part to Dell. Replacement parts are new or reconditioned. Dell may provide replacement parts made by various manufacturers when supplying parts to you. The warranty term for a replacement part is the remainder of the limited warranty term.

You will pay Dell for replacement parts if the replaced part is not returned to Dell. The process for returning replaced parts, and your obligation to pay for replacement parts if you do not return the replaced parts to Dell, will be in accordance with Dell's Exchange Policy in effect on the date of the exchange.

You accept full responsibility for your software and data. Dell is not required to advise or remind you of appropriate backup and other procedures.

General Provisions

DELL MAKES NO EXPRESS WARRANTIES OR CONDITIONS BEYOND THOSE STATED IN THIS LIMITED WARRANTY STATEMENT. DELL DISCLAIMS ALL OTHER WARRANTIES AND CONDITIONS, EXPRESS OR IMPLIED, INCLUDING WITHOUT LIMITATION IMPLIED WARRANTIES AND CONDITIONS OF MERCHANTABILITY AND FITNESS FOR A PARTICULAR PURPOSE. SOME STATES (OR JURISDICTIONS) DO NOT ALLOW LIMITATIONS ON IMPLIED WARRANTIES OR CONDITIONS, SO THIS LIMITATION MAY NOT APPLY TO YOU.

DELL'S RESPONSIBILITY FOR MALFUNCTIONS AND DEFECTS IN HARDWARE IS LIMITED TO REPAIR AND REPLACEMENT AS SET FORTH IN THIS LIMITED WARRANTY STATEMENT. THESE WARRANTIES GIVE YOU SPECIFIC LEGAL RIGHTS, AND YOU MAY ALSO HAVE OTHER RIGHTS, WHICH VARY FROM STATE TO STATE (OR JURISDICTION TO JURISDICTION).

DELL DOES NOT ACCEPT LIABILITY BEYOND THE REMEDIES SET FORTH IN THIS LIMITED WARRANTY STATEMENT OR LIABILITY FOR INCIDENTAL OR CONSEQUENTIAL DAMAGES, INCLUDING WITHOUT LIMITATION ANY LIABILITY FOR PRODUCTS NOT BEING AVAILABLE FOR USE OR FOR LOST DATA OR SOFTWARE.

SOME STATES (OR JURISDICTIONS) DO NOT ALLOW THE EXCLUSION OR LIMITATION OF INCIDENTAL OR CONSEQUENTIAL DAMAGES, SO THE PRECEDING EXCLUSION OR LIMITATION MAY NOT APPLY TO YOU.

These provisions apply to Dell's two-year limited warranty only. For provisions of any service contract covering your system, refer to your invoice or the separate service contract that you will receive.

If Dell elects to exchange a system or component, the exchange will be made in accordance with Dell's Exchange Policy in effect on the date of the exchange. In any instance in which Dell issues a Return Material Authorization Number, Dell must receive the product(s) for repair prior to the expiration of the warranty period in order for the repair(s) to be covered by the limited warranty.

Three-Year Limited Warranty (Canada Only)

Dell Computer Corporation ("Dell") manufactures its hardware products from parts and components that are new or equivalent to new in accordance with industry-standard practices. Dell warrants that the hardware products it manufactures will be free from defects in materials and workmanship. The warranty term is three years beginning on the date of invoice, as described in the following text.

Damage due to shipping the products to you is covered under this limited warranty. Otherwise, this limited warranty does not cover damage due to external causes, including accident, abuse, misuse, problems with electrical power, servicing not authorized by Dell, usage not in accordance with product instructions, failure to perform required preventive maintenance, and problems caused by use of parts and components not supplied by Dell.

This limited warranty does not cover any items that are in one or more of the following categories: software; external devices (except as specifically noted); accessories or parts added to a Dell system after the system is shipped from Dell; accessories or parts added to a Dell system through Dell's system integration department; accessories or parts that are not installed in the Dell factory; or DellWare products. Monitors, keyboards, and mice that are Dell-branded or that are included on Dell's standard price list are covered under this limited warranty; all other monitors, keyboards, and mice (including those sold through the DellWare program) are not covered. Batteries for portable computers are covered only during the initial one-year period of this limited warranty.

Coverage During Year One

During the one-year period beginning on the invoice date, Dell will repair or replace products covered under this limited warranty that are returned to Dell's facility. To request warranty service, you must contact Dell's Customer Technical Support within the warranty period. See "Contacting Dell" on page 73 to find the appropriate contact information for obtaining customer assistance. If warranty service is required, Dell will issue a Return Material Authorization Number. You must ship the products back to Dell in their original or equivalent packaging, prepay shipping charges, and insure the shipment or accept the risk of loss or damage during shipment. Dell will ship the repaired or replacement products to you freight prepaid if you use an address in Canada, where applicable. Shipments to other locations will be made freight collect.



NOTE: Before you ship the product(s) to Dell, back up the data on the hard drive(s) and any other storage device(s) in the product(s). Remove any removable media, such as floppy disks, CDs, or PC Cards. Dell does not accept liability for lost data or software.

Dell owns all parts removed from repaired products. Dell uses new and reconditioned parts made by various manufacturers in performing warranty repairs and building replacement products. If Dell repairs or replaces a product, its warranty term is not extended.

Coverage During Years Two and Three

During the second and third years of this limited warranty, Dell will provide, on an exchange basis and subject to Dell's Exchange Policy in effect on the date of the exchange, replacement parts for the Dell hardware product(s) covered under this limited warranty when a part requires replacement. You must report each instance of hardware failure to Dell's Customer Technical Support in advance to obtain Dell's concurrence that a part should be replaced and to have Dell ship the replacement part. Dell will ship parts (freight prepaid) if you use an address in Canada, where applicable. Shipments to other locations will be made freight collect. Dell will include a prepaid shipping container with each replacement part for your use in returning the replaced part to Dell. Replacement parts are new or reconditioned. Dell may provide replacement parts made by various manufacturers when supplying parts to you. The warranty term for a replacement part is the remainder of the limited warranty term.

You will pay Dell for replacement parts if the replaced part is not returned to Dell. The process for returning replaced parts, and your obligation to pay for replacement parts if you do not return the replaced parts to Dell, will be in accordance with Dell's Exchange Policy in effect on the date of the exchange.

You accept full responsibility for your software and data. Dell is not required to advise or remind you of appropriate backup and other procedures.

General Provisions

DELL MAKES NO EXPRESS WARRANTIES OR CONDITIONS BEYOND THOSE STATED IN THIS LIMITED WARRANTY STATEMENT. DELL DISCLAIMS ALL OTHER WARRANTIES AND CONDITIONS, EXPRESS OR IMPLIED, INCLUDING WITHOUT LIMITATION IMPLIED WARRANTIES AND CONDITIONS OF MERCHANTABILITY AND FITNESS FOR A PARTICULAR PURPOSE. SOME STATES (OR JURISDICTIONS) DO NOT ALLOW LIMITATIONS ON IMPLIED WARRANTIES OR CONDITIONS, SO THIS LIMITATION MAY NOT APPLY TO YOU.

DELL'S RESPONSIBILITY FOR MALFUNCTIONS AND DEFECTS IN HARDWARE IS LIMITED TO REPAIR AND REPLACEMENT AS SET FORTH IN THIS LIMITED WARRANTY STATEMENT. THESE WARRANTIES GIVE YOU SPECIFIC LEGAL RIGHTS, AND YOU MAY ALSO HAVE OTHER RIGHTS, WHICH VARY FROM STATE TO STATE (OR JURISDICTION TO JURISDICTION).

DELL DOES NOT ACCEPT LIABILITY BEYOND THE REMEDIES SET FORTH IN THIS LIMITED WARRANTY STATEMENT OR LIABILITY FOR INCIDENTAL OR CONSEQUENTIAL DAMAGES, INCLUDING WITHOUT LIMITATION ANY LIABILITY FOR PRODUCTS NOT BEING AVAILABLE FOR USE OR FOR LOST DATA OR SOFTWARE.

SOME STATES (OR JURISDICTIONS) DO NOT ALLOW THE EXCLUSION OR LIMITATION OF INCIDENTAL OR CONSEQUENTIAL DAMAGES, SO THE PRECEDING EXCLUSION OR LIMITATION MAY NOT APPLY TO YOU.

These provisions apply to Dell's three-year limited warranty only. For provisions of any service contract covering your system, refer to your invoice or the separate service contract that you will receive.

If Dell elects to exchange a system or component, the exchange will be made in accordance with Dell's Exchange Policy in effect on the date of the exchange. In any instance in which Dell issues a Return Material Authorization Number, Dell must receive the product(s) for repair prior to the expiration of the warranty period in order for the repair(s) to be covered by the limited warranty.

“Total Satisfaction” Return Policy (U.S. and Canada Only)

If you are an end-user customer who bought new products directly from a Dell company, you may return them to Dell within 30 days of the date of invoice for a refund or credit of the product purchase price. If you are an end-user customer who bought reconditioned or refurbished products from a Dell company, you may return them to Dell within 14 days of the date of invoice for a refund or credit of the product purchase price. In either case, the refund or credit will not include any shipping and handling charges shown on your invoice. If you are an organization that bought the products under a written agreement with Dell, the agreement may contain different terms for the return of products than specified by this policy.

To return products, you must contact Dell Customer Service to receive a Credit Return Authorization Number. See “Contacting Dell” on page 73 to find the appropriate contact information for obtaining customer assistance. To expedite the processing of your refund or credit, Dell expects you to return the products to Dell in their original packaging within five days of the date that Dell issues the Credit Return Authorization Number. You must also prepay shipping charges and insure the shipment or accept the risk of loss or damage during shipment. You may return software for refund or credit only if the sealed package containing the diskette(s) or CD(s) is unopened. Returned products must be in as-new condition, and all of the manuals, diskette(s), CD(s), power cables, and other items included with a product must be returned with it. For customers who want to return, for refund or credit only, either applications software or an operating system that has been installed by Dell, the whole system must be returned, along with any media and documentation that may have been included in the original shipment.

This “Total Satisfaction” Return Policy does not apply to DellWare products, which may be returned under DellWare's then-current return policy. In addition, reconditioned parts purchased through Dell Spare Parts Sales in Canada are nonreturnable.

One-Year End-User Manufacturer Guarantee (Latin America and the Caribbean Only)

Guarantee

Dell Computer Corporation (“Dell”) warrants to the end user in accordance with the following provisions that its branded hardware products, purchased by the end user from a Dell company or an authorized Dell distributor in Latin America or the Caribbean, will be free from defects in materials, workmanship, and design affecting normal use, for a period of one year from the original purchase date. Products for which proper claims are made will, at Dell’s option, be repaired or replaced at Dell’s expense. Dell owns all parts removed from repaired products. Dell uses new and reconditioned parts made by various manufacturers in performing repairs and building replacement products.

Exclusions

This Guarantee does not apply to defects resulting from: improper or inadequate installation, use, or maintenance; actions or modifications by unauthorized third parties or the end user; accidental or willful damage; or normal wear and tear.

Making a Claim

Claims must be made in Latin America or the Caribbean by contacting the Dell point of sale within the guarantee period. The end user must always supply proof of purchase, indicating name and address of the seller, date of purchase, model and serial number, name and address of the customer, and details of symptoms and configuration at the time of malfunction, including peripherals and software used. Otherwise, Dell may refuse the guarantee claim. Upon diagnosis of a warranted defect, Dell will make arrangements and pay for ground freight and insurance to and from Dell’s repair/replacement center. The end user must ensure that the defective product is available for collection properly packed in original or equally protective packaging together with the details listed above and the return number provided to the end user by Dell.

Limitation and Statutory Rights

Dell makes no other warranty, guarantee or like statement other than as explicitly stated above, and this Guarantee is given in place of all other guarantees whatsoever, to the fullest extent permitted by law. In the absence of applicable legislation, this Guarantee will be the end user's sole and exclusive remedy against Dell or any of its affiliates, and neither Dell nor any of its affiliates shall be liable for loss of profit or contracts, or any other indirect or consequential loss arising from negligence, breach of contract, or howsoever.

This Guarantee does not impair or affect mandatory statutory rights of the end user against and/or any rights resulting from other contracts concluded by the end user with Dell and/or any other seller.

Dell World Trade LP

One Dell Way, Round Rock, TX 78682, USA

Dell Computadores do Brasil Ltda (CNPJ No. 72.381.189/0001-10)/

Dell Commercial do Brasil Ltda (CNPJ No. 03 405 822/0001-40)

Avenida Industrial Belgraf, 400

92990-000 - Eldorado do Sul – RS - Brasil

Dell Computer de Chile Ltda

Coyancura 2283, Piso 3- Of.302,

Providencia, Santiago - Chile

Dell Computer de Colombia Corporation

Carrera 7 #115-33 Oficina 603

Bogota, Colombia

Dell Computer de Mexico SA de CV

Paseo de la Reforma 2620 - 11° Piso

Col. Lomas Altas

11950 México, D.F.

Index

A

advanced port replicator
 about, 51
 connecting to a network, 22
APR
 about, 51
 connecting to a network, 22
audio. *See* sound

B

BIOS, 72

C

CD drive
 fixing problems, 37
CD-RW drive
 fixing problems, 38
characters
 unexpected, 35
computer
 crashes, 40
 error messages, 29
 specifications, 66
 turning off, 18
contact numbers, 73
crashes, 40

D

damaged computer
 testing, 43
display
 fixing problems, 30
Dolby Headphone
 setting up, 22
drives
 fixing problems, 36
DVD drive
 fixing problems, 38

E

electrostatic discharge. *See*
 ESD
e-mail
 fixing problems, 42
error messages
 start-up, 29
 Windows, 39
ESD, 13
external keyboard
 fixing problems, 35

F

finding solutions, 26
floppy drive
 fixing problems, 36

G

grounding procedure, 12

H

hard drive
 fixing problems, 38
 preventing damage, 63
 preventing data loss, 62
 replacing, 62
 returning to Dell, 64
 troubleshooting, 38
help file
 accessing, 28
hibernate file
 enabling support, 48

I

Internet
 fixing problems, 41

K

- keyboard
 - fixing problems, 35
 - unexpected characters, 35

M

- media bay
 - devices, 19
 - swapping devices (active mode), 21
- memory
 - adding, 57
 - removing, 58
- messages
 - start-up, 29
 - Windows, 39
- modem
 - fixing problems, 33

N

- network
 - fixing problems, 39
 - setting up the APR, 22

P

- port replicator
 - connecting to a network, 22
- power
 - fixing problems, 28
 - turning off, 18
- printer
 - connecting, 16
 - fixing problems, 32
 - reinstalling driver, 16

- printer (*continued*)
 - setting up, 16
 - troubleshooting, 32

- programs
 - crashes, 40
 - fixing problems, 40
 - not responding, 40

R

- RAM. *See* memory
- regulatory notices, 88
- reinstalling drivers and utilities, 44
- return policy, 111

S

- safety instructions
 - ESD prevention, 13
 - working inside your computer, 12
- ScanDisk, 38
- settings
 - system setup program, 72
- shutdown, 18
- software
 - fixing problems, 40
- sound
 - adjusting volume, 31
 - fixing problems, 31
- speaker
 - adjusting volume, 31
 - fixing problems, 31
- specifications, 66

- system setup program, 72

T

- technical assistance
 - telephone numbers and addresses, 73
 - warranty repair or credit, 87
- Tell Me How help file
 - accessing, 28
- touch pad
 - fixing problems, 35
- troubleshooting
 - about, 26
 - blank display, 30
 - blue screen, 41
 - cannot play a DVD movie, 38
 - cannot save to floppy disk, 36
 - CD problems, 37
 - CD-RW drive stops writing, 38
 - display difficult to read, 30
 - dropped or damaged computer, 43
 - e-mail problems, 42
 - external keyboard problems, 35
 - external speaker problems, 31
 - integrated speaker problems, 31
 - Internet connection problems, 41
 - modem problems, 33
 - network problems, 39
 - parallel printer problems, 32
 - power problems, 28
 - program crash, 40
 - program stopped responding, 40

troubleshooting (*continued*)
 scanner problems, 34
 start-up error messages, 29
 touch pad problems, 35
 unexpected characters, 35
 USB printer problems, 33
 wet computer, 42
 Windows error messages, 39
turning off the computer, 18

V
video
 fixing problems, 30

W
warranty, 93
wet computer, 42
Windows 2000
 error messages, 39
 Help, 28
 reinstalling, 47
Windows Me
 error messages, 39
 Help, 28
 reinstalling, 45
 shutdown, 18

